

# Physics

**for Rwanda Secondary Schools**

## **Teacher's Guide Book 4**

**Writing Team**

Christian Birindwa

Alex Atwebembeire

**FOUNTAIN PUBLISHERS**  
[www.fountainpublishers.co.ug](http://www.fountainpublishers.co.ug)

Fountain Publishers Rwanda Ltd  
P. O. Box 6567 Kigali  
E-mail: fountainpublishers.rwanda@gmail.com

E-mail: sales@fountainpublishers.co.ug  
publishing@fountainpublishers.co.ug  
Website: www.fountainpublishers.co.ug

© Fountain Publishers 2016  
First published 2016

All rights reserved. No part of this publication may be reproduced, stored in a retrieval system or transmitted in any form or by any means electronic, mechanical, photocopying, recording or otherwise without the prior written permission of the publisher.

ISBN: 978-9970-19-370-7

# Contents

---

<i>Introduction</i> .....	v
<i>Structure of the Subject</i> .....	vi
<i>Format of Unit Plan/Scheme of work</i> .....	xi
<i>A competence based lesson plan</i> .....	xii
<i>Content map</i> .....	xiv
UNIT 1 Thin Lenses .....	1
Unit Breakdown.....	1
UNIT 2 Simple and compound optical instruments .....	25
Unit Breakdown.....	26
UNIT 3 Moments and Equilibrium of Bodies .....	50
Unit Breakdown.....	51
UNIT 4 Work, Energy and Power .....	69
Unit Breakdown.....	69
UNIT 5 Kirchhoff's Laws and Electric Circuits .....	81
Unit Breakdown.....	83
UNIT 6 Sources of Energy in the World .....	111
Unit Breakdown.....	112
UNIT 7 Energy Degradation (Dilapidation) and Power Generation.....	124
Unit Breakdown.....	125
UNIT 8 Projectile and Uniform Circular Motion .....	135
Unit Breakdown.....	135
UNIT 9 Universal Gravitational Field .....	148
Unit Breakdown.....	148
UNIT 10 Effects of Electric and Electric Potential Fields.....	161
Unit Breakdown.....	162
UNIT 11 Applications of laws of thermodynamics.....	185
Unit Breakdown.....	185
UNIT 12 General Structure of the Solar System .....	218
Unit Breakdown.....	219



# Introduction

---

Physics can be regarded as the most fundamental of the natural sciences. Physics has made significant contributions to advances in new technologies through understanding of scientific phenomena and theories critical to the development of new products that have dramatically transformed modern-day society. These include television, computers, domestic appliances and nuclear weapons. Advances in thermodynamics led to industrialisation and advances in mechanics and inspired the development of calculus.

Physics like any other science subject **MUST** always be taught practically either in class, outside the class or in laboratory.

# Structure of the Subject

---

## **Component Time Weighting of Physics**

Paper 1 consists of two sections; A and B.

Section A: Multiple Choice Questions

Section B: Structured short answer questions. This section consists of 40 multiple choice questions, with four options. This section consists of variable mark value. Candidates will answer all questions. Candidates will write their answers on spaces provided in the question paper. All questions will be based on the syllabus content.

**Multiple choice (Section A) 40%**

Structured short answer questions (Section B) 60%

Time: 2hr 30 min. Paper 2 consists of a compulsory question with number of parts each with a variable mark value (Section A)

- A choice of three free response style or extended essay questions from five questions worth 20 marks (Section B). All questions will be based on the syllabus but may require knowledge of material first encountered in the previous syllabus of the same subject.

**(Section A) 40% (section B) 60%**

Paper 3: Advanced Practical Skills

This paper requires candidates to carry out practical work in timed conditions. This paper will consist of experiments drawn from different areas of the a syllabus. Candidates will answer all questions. Candidates will write down their answers on spaces provided in question paper.

**Time: 3hr. 00min**

Total marks: 100%

### **Planning of the lesson**

- Lesson plan must contain clear, realistic and appropriate SMART objectives reflected in the syllabus unit;
- The planned lesson must be conducted within the time allocated in the lesson plan;
- The management and control of the class must be effective and indication of how to address individual learner's needs is paramount.

### **Introduction of the lesson**

1. The teacher must discuss lesson objectives or learning outcomes with the learners and these must reflect the rationale for learning the subject unit.
2. The introduction must:
  - show the linkage between prior knowledge to new concept and how learners demonstrate the existence of prior knowledge;
  - emphasise on how the new concept is applied in everyday life experience;
  - be stimulating enough to capture the learner's interest.

### **Pedagogical Approach**

- Teacher through questioning and provocation engages learners in active participation in the lesson.
- Teacher encourages learners to work in groups in order to accomplish a given task.
- Teacher encourages learners to ask questions and to give their views.
- Teacher pays particular attention to slow learners and those with special needs.
- Teacher adapts to the needs of the learner.

### **Assessment Technique**

- Teacher asks provocative and challenging questions as the lesson progresses.

- Teacher gives class exercise and moves around to check the accuracy of responses from learners.
- Teacher discusses the exercise with the learners.
- Teacher discusses responses to the exercise with learners.
- Teacher sets tasks for small groups to work on.
- Teacher involves learners in discussing the group findings.
- Teacher gives home work or project work at the end of the lesson.

### **Instructional materials used**

- Learners make use of text books during the lesson.
- Learners utilise materials provided by the teacher to facilitate their learning.
- Teacher makes use of the teacher's guide and existing instructional materials relevant to the topic.
- Teacher makes use of charts, maps, common tools, models, overhead projector, flip board or white board, relevant reference books, video and cassette player, computers, sufficient books in the library.

### **Conclusion of the lesson**

- The teacher summarises the lesson and encourages the learners to ask questions on what was not clear.
- Teacher emphasises the relevance and applications of the concept; learnt in real life experiences.
- The teacher concludes the lesson by giving follow up assignment to the learners.

### **Teacher Competences Required**

- Teacher adapts to the needs of the learners.
- The teacher's communication skills in the language of instruction.
- The teacher's practical skills during the lesson.
- The teacher's management of relevant records.
- The teacher's ability to evaluate oneself and learners.

## **Assessment**

### **Why Assess?**

The teacher should carry out assessment because it helps in:



- finding out how much a learner has achieved.
- inform learners what they have achieved and encourage them to improve further.
- making decisions on the next steps in terms of progress.
- make new plans for effective teaching and learning.
- keeping records and measuring progress.
- the identification of learners who are gifted and talented for provision of enrichment work and those who are struggling and need support.
- setting of activities to assess learners appropriately.
- the motivation of learners to learn and succeed.
- provision of feedback to learners, parents and teachers.
- helping learners take control of their own learning.

### **The roles of the teacher and learners in competence-based assessment**

1. The teacher:

- should be clear about what he/she intends to assess and how to do it.

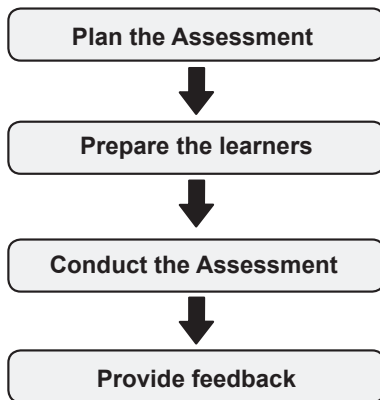

### **When planning an assessment activity, the teacher should:**

- be clear about the purpose of the assessment;
- understand, plan and design the process to be applied;
- ensure that assessment always supports learning;
- prepare learners for the assessment;

- carry out assessment as an ongoing part of classroom learning and teaching and periodically use specific assessments, tests or examinations as appropriate;
- involve learners fully in assessment and help them to understand what is expected and how to improve;
- develop learners' roles in self-assessment;
- evaluate evidence of learning to contribute to profiles and report on learners' achievements and progress.

**Learners are expected to:**

- actively engage in assessment for learning.
- use clear understanding of assessment expectations to demonstrate their knowledge and understanding, skills, attitudes and values through a wide range of evidence including informal and formal assessments including specific assessment tasks, activities, tests and examinations.
- use assessment feedback to shape and review their learning by reflection, setting learning goals and planning next steps.
- use self-assessment to improve performance.
- collaborate in peer assessment.

## Format of Unit Plan/Scheme of work

---

Academic year: ..... Term: .....

School: ..... Subject:.....

Teacher's name: ..... Class + Combination: .....

Number of periods per week .....

<b>Dates &amp; number of lessons (periods) in a week</b>	<b>Units</b>	<b>Lessons + Evaluation</b>	<b>Learning objectives + Key unit competences</b>	<b>Teaching methods &amp; techniques + Evaluation procedures</b>	<b>Resources &amp; References</b>	<b>Observations</b>
From January 11 (Mo) to January 15 (Friday) 3 periods	Unit 1	Lesson 1 Lesson 2 Lesson 3	General Objective			
From January 18 (Mo) to January 22 (Friday) 3 periods	Unit 1	Lesson 4 Lesson 5	General Objective			
		Lesson 6	General objective			
From January 25 (Mo) to January 29 (Friday) 3 periods	Unit 1	Lesson 7 Lesson 8	General Objective			
		Summative Evaluation 1		Evaluation procedures		
From Feb 01 (Mo) to Feb 05 (Friday) 3 periods	Unit 1	Lesson 9 Lesson 10 Lesson 11	General objective			
In this week, the 3 periods will be: last lesson of unit 1, evaluation for unit 19 and first lesson for unit 2	Unit 1	Lesson 12	General Objective			
		Summative Evaluation 2		Evaluation procedures		
	Unit 2	Lesson 1	General objective			
Unit 2	Lesson 1 Lesson 2 Lesson 3					
	Unit 2	Lesson 4 ...	General objective			

# A competence based lesson plan

School Name: .....

Teacher's Name: .....

Term	Date	Subject	Class	Unit No.	Lesson No.	Duration	Class size
1	15/8/2016	Physics	S4	1	1 of 1	80min	80
<b>Type of Special Education Needs to be catered for in this lesson and number of learners in each category.</b>				Learners with SEN 1. Visual impairment 2. Hearing difficulties 3. Gifted and talented			
<b>Unit title</b>		<b>Thin lenses</b>					
<b>Key unit competences</b>		Be able to explain the properties of lenses and image formation by lenses.					
<b>Title of the lesson</b>		Types of lenses and their characteristics					
<b>Instructional Objective</b>		At the end of the lesson, learners should be able to: <ul style="list-style-type: none"> <li>• explain the angle of refraction of a thin lens</li> <li>• measure the angle of refraction of each type of lens</li> <li>• define a thin lens based on its angle of refraction</li> <li>• describe the physical features of each type of lens</li> <li>• name the different types of lenses based on their physical features</li> <li>• describe the characteristics of each type of lens with respect to the size of the images of objects seen through the lens</li> </ul>					
<b>Plan for this class (location: in / outside):</b> This lesson will be conducted inside a classroom or Physics laboratory in groups							
<b>Learning materials ( for all learners):</b> Each group should have: 2 convex lenses, 2 concave lenses, a flash light and an A4 white photocopying paper.							
<b>References:</b> Physics for Rwanda: Learners' book 4 Physics for Rwanda: Teacher's book 4							
<b>Steps/Time for each step</b>							
<b>Introduction</b>		Teacher's Activities		Learner's Activities		Competences to be focused on:	
<b>(5 min)</b>		<ul style="list-style-type: none"> <li>• Using thought provoking and challenging questions,</li> <li>• review previous learning in relation to the current topic</li> </ul>		<ul style="list-style-type: none"> <li>• Provide relevant responses, thoughts and ideas in an effort to answer the questions.</li> </ul>		<ul style="list-style-type: none"> <li>• Reinforcement of previously learnt knowledge in thin lenses. Transfer of and application of previously learnt knowledge.</li> </ul>	
<b>(4 min)</b>		<ul style="list-style-type: none"> <li>• Describe and explain the learning outcomes expected at the end of the lesson.</li> </ul>		<ul style="list-style-type: none"> <li>• Pose questions, make suggestions and form conclusions</li> </ul>		<ul style="list-style-type: none"> <li>• Development of the scientific method of carrying out scientific investigations.</li> </ul>	
<b>(3 min)</b>		<ul style="list-style-type: none"> <li>• Instruct the learners to form groups, each of four members with a fair distribution of boys and girls.</li> </ul>		<ul style="list-style-type: none"> <li>• Form groups and select group leaders.</li> </ul>		<ul style="list-style-type: none"> <li>• Exercise of the democratic process.</li> <li>• Development of leadership qualities.</li> </ul>	

<b>Description of teaching and learning activity</b>			
<b>Development of the lesson</b> <b>(3 min)</b>	<ul style="list-style-type: none"> <li>Distribute learning materials and printed instructions to each of the groups.</li> </ul>	<ul style="list-style-type: none"> <li>Ensure that they have the correct learning materials.</li> </ul>	<ul style="list-style-type: none"> <li>Identification of learning materials.</li> <li>Development of the spirit of accountability.</li> </ul>
<b>(5 min)</b>	<ul style="list-style-type: none"> <li>Set the learners to start the activities they have been instructed to carry out.</li> </ul>	<ul style="list-style-type: none"> <li>Read the instructions carefully and ask questions on unclear instructions.</li> </ul>	<ul style="list-style-type: none"> <li>Develop the sense of collective responsibility.</li> <li>Skill in following the scientific method during experimentation.</li> </ul>
<b>(35 min)</b>	<ul style="list-style-type: none"> <li>Set the learners to start the activities they have been instructed to carry out.</li> <li>Move around the class and monitor the progress of the learners in carrying out the experiments. Guide those in need but do not take over the exercise.</li> </ul>	<ul style="list-style-type: none"> <li>Perform the activities as assigned.</li> <li>Manipulate, describe, measure whatever has been specified and write a record of the findings.</li> </ul>	<ul style="list-style-type: none"> <li>Setting up of experiments</li> <li>According to the instructions given.</li> <li>Delicate handling of learning materials.</li> <li>Accurate measurement of various dimensions as required in the experiment.</li> </ul>
<b>(3 min)</b>	<ul style="list-style-type: none"> <li>When a common problem to a number of groups is noticed, halt all groups from continuing with the exercise and advise them on how to overcome the problem then allow them to continue with their work.</li> </ul>	<ul style="list-style-type: none"> <li>Listen to the teacher and follow the suggested corrective actions. Ask relevant questions when the suggestions are not well understood.</li> </ul>	<ul style="list-style-type: none"> <li>Attention to detail as demanded by the level or degree of accuracy required of the learners.</li> </ul>
<b>(2 min)</b>	<ul style="list-style-type: none"> <li>Give notice to your learners on how much time they are left with to complete their work. Advise them to develop a report which will be presented by the respective group leaders.</li> </ul>	<ul style="list-style-type: none"> <li>Complete their assigned work and develop the group report to be presented to the whole class.</li> </ul>	<ul style="list-style-type: none"> <li>Skills in group report development and writing.</li> <li>Skills in Report presentation in the Microsoft Power Point format.</li> </ul>
<b>(15min)</b>	<ul style="list-style-type: none"> <li>Stop all groups from working.</li> <li>Discuss with your learners and agree on the order of presenting reports.</li> <li>Ask the group leaders to present their reports following the order agreed upon.</li> <li>Ask leading and thought provoking questions and develop with the learners appropriate and systematic notes.</li> </ul>	<ul style="list-style-type: none"> <li>Discuss the various reports with the teacher and develop good notes.</li> <li>Write the developed notes in notebooks</li> </ul>	<ul style="list-style-type: none"> <li>Skills in organising scattered data to develop systematic, observation and detailed presentations.</li> </ul>
<b>Conclusion:</b> <b>Summary</b> <b>Assessment (5 min)</b>	<ul style="list-style-type: none"> <li>Ask the learners to close their note books. With the use of probing and challenging questions, review what has been carried out.</li> </ul>	<ul style="list-style-type: none"> <li>Respond to the questions asked by the teacher.</li> <li>Ask questions on areas not clearly understood</li> </ul>	<ul style="list-style-type: none"> <li>Definition of a thin lens, explanation of the basic characteristics of different types of thin lenses.</li> <li>Description &amp; measurement of refractive angle of a lens</li> </ul>
<b>Teacher self-evaluation</b>	<p>From the responses of the learners, determine whether the stated objectives were achieved or not. If the objectives were not achieved, was it because of the method used or was it a problem related to manipulation of the learning materials? Find out what could have been done in order to enrich the learning experiences.</p>		

# Content map

Unit	1 Thin lenses	2 Simple and compound optical instruments	3. Moments and equilibrium of forces	4 Work energy and power	5 Kirchhoff's laws and electric circuits	6 Sources of energy in the world
No of periods	24	18	19	19	20	20
Introduction	<ul style="list-style-type: none"> <li>Ask learners if they have ever seen a person wearing eye glasses.</li> <li>Ask them to read some prints on paper. Guide the learners and tell them that we actually use a lens in the eyes to read.</li> <li>Display the different types of lenses and let the learners observe and ask questions.</li> <li>Guide learners to come up with the topic and the objective of the lesson</li> </ul>	<ul style="list-style-type: none"> <li>Display a hand lens, a lens camera, and a compound microscope on a table and call learners to come forward and observe and have a touch.</li> <li>Ask learners to tell which instruments they have seen and what they are used for.</li> </ul>	<ul style="list-style-type: none"> <li>Review on previous lesson by asking questions about the previous lesson taught (orally).</li> <li>Ask challenging questions that will lead the learners to understand the use of the content in everyday life</li> <li>Facilitate how learners give their predictions and help them to come up with the topic and the objective of the lesson</li> </ul>	<ul style="list-style-type: none"> <li>Review on previous lesson by asking questions about the previous lesson taught (orally).</li> <li>Ask challenging questions that will lead the learners to understand the use of the content in everyday life</li> <li>Facilitate how learners give their predictions and help them to come up with the topic and the objective of the lesson</li> </ul>	<ul style="list-style-type: none"> <li>Provide learners with cells in a cell holder, a voltmeter and instruct them to connect the voltmeter across the terminals.</li> <li>Ask them the observation.</li> <li>Instruct them to connect an ammeter in series with the cells. Let them tell their observations.</li> <li>Guide them to discover the topic.</li> </ul>	<ul style="list-style-type: none"> <li>Ask learners to tell the sources of fuel in their homes.</li> <li>Ask them the different sources of energy used in their homes.</li> </ul>
Class room organization	Whole class orientation ( row and columns depending on the size of the class).  group work;  individual work	Whole class orientation; group work; individual work	Whole class orientation; group work; pair work; individual work.	Whole class orientation;  group work;  pair work;  individual work.	Whole class orientation; group work; pair work; individual work	Whole class orientation; group work; pair work; individual work
Equipment required	Concave and Convex lenses, candles, light bulbs, optical bench, torches, eye glasses, Sets, graph papers.	Convex mirror, hand lens, lens camera, paper with prints, compound microscope, Mathematical set, graph papers.	Mathematical Set, Video tapes, CD's  Calculators.	Mathematical Set, Calculators  Pendulum bob.	Ammeter, voltmeter, resistors, bulbs, cells, metre rules, rheostat and connecting wires.	Fire wood, solar panel, wind hawk (made from local material).

	7 Energy degradation (dilapidation) and power generation	8 Projectile and uniform circular motion.	9 Universal gravitational field strength	10 Effects of electric and potential fields.	11 Application of thermodynamic laws.	12 General structure of the solar system
	20	20	20	24	24	20
	<ul style="list-style-type: none"> <li>Ask learners the different ways of generating energy.</li> <li>Ask challenging questions that will lead the learners to understand the use of the content in every day life.</li> <li>Facilitate how learners give their predictions and help them to come up with the topic and the objective of the lesson</li> </ul>	<ul style="list-style-type: none"> <li>Review on previous lesson by asking questions about the previous lesson taught (orally).</li> <li>Ask challenging questions that will lead the learners to understand the use of the content in everyday life</li> <li>Facilitate how learners give their predictions and help them to come up with the topic and the objective of the lesson</li> </ul>	<ul style="list-style-type: none"> <li>Review on previous lesson by asking questions about the previous lesson taught (orally).</li> <li>Ask challenging questions that will lead the learners to understand the use of the content in everyday life</li> <li>Facilitate how learners give their predictions and help them to come up with the topic and the objective of the lesson</li> </ul>	<ul style="list-style-type: none"> <li>Let each learner rub his/ her pen with hair, and place it closer to a small piece of paper.</li> <li>Ask them their observations.</li> </ul>	<ul style="list-style-type: none"> <li>Ask learners to state the ways through which heat is transferred in the three states of matter. Ask them if heat can be exchanged from one state to another.</li> <li>Let the learners Inflate a balloon and leave it to move up during a sunny day.</li> <li>Let them discuss in groups why a balloon or a bicycle tube bursts when left in sunshine for long and why a loose sauce pan cover goes off during the cooking.</li> </ul>	<ul style="list-style-type: none"> <li>Ask learners to list down the name of all planets in the universe.</li> <li>Provide the learners with a globe and rotate it; ask them to describe the kind of motion.</li> <li>Ask the learners what they see in the sky at night.</li> <li>Ask the learners what causes days and nights and seasons in a year.</li> <li>Guide the learners in their discussions.</li> </ul>
	Whole class orientation; group work; pair work; individual work	Whole class orientation; group work; pair work; individual work	Whole class orientation; group work; pair work; individual work	Whole class orientation; group work; pair work; individual work	Whole class orientation; group work; pair work; individual work	Whole class orientation; group work; pair work; individual work
	Paper and pens or PC and Printer  Compass, Powerful magnet  100' small-gauge insulated copper magnet wire	Mathematical Set, Calculators Pendulum bob, balls, bicycle. Stones, balls, chalk, shot put stone Spinning drier	Mathematical Set, Calculators Pendulum bob.	Ebonite rod, pens, small pieces of papers, metal plates, lightning arrestor.	Balloons, thermometers, syringe, bicycle pumps, sauce pan, refrigerator, diesel engine, petrol engine.	Globe, balloons, torch, telescope, binoculars

Unit	1 Thin lenses	2 Simple and compound optical instruments	3. Moments and equilibrium of forces	4 Work energy and power	5 Kirchhoff's laws and electric circuits	6 Sources of energy in the world
Activities	<ul style="list-style-type: none"> <li>Observing different types of lenses.</li> <li>Experiments to examine the characteristics of images formed by lenses.</li> <li>Experiments to determine the focal length of a lens.</li> <li>Experiment to determine the refractive index using a prism.</li> <li>Learners to view different parts of small organisms using lenses.</li> </ul>	<ul style="list-style-type: none"> <li>Observing small organisms using a hand lens, observe far and near objects, using a compound microscope to examine small organisms.</li> <li>Deriving expressions for magnifying power of each instrument.</li> <li>Visiting neighboring places to see television sets/ dishes.</li> </ul>	<ul style="list-style-type: none"> <li>Learners in small groups brainstorm on different types of forces, definition of forces, scalar and vector quantities, moment of force, conditions for a body to be in equilibrium, exercises.</li> </ul>	<ul style="list-style-type: none"> <li>Learners in small groups brainstorm on the difference between work energy and power.</li> <li>Swing a pendulum bob and discuss in groups the different forms of energy it possesses at the different positions.</li> <li>Make two balls to collide and observe. Then discuss in groups the different types of collisions.</li> <li>Discuss in groups the impact of collisions on bodies</li> </ul>	<ul style="list-style-type: none"> <li>Making a simple circuit.</li> <li>Construct a series circuit and parallel circuits.</li> <li>Find experimentally the emf and internal resistance of a cell</li> <li>Find the relation between the emf and potential difference at terminals of a cell</li> <li>Find the characteristics of cells wired in series and in parallel.</li> </ul>	<ul style="list-style-type: none"> <li>Discuss in groups the different sources of energy in Rwanda.</li> <li>Visit the power generation plant near by for example hydro electric or biogas plant.</li> </ul>
Competence practiced.	<ul style="list-style-type: none"> <li>Examining different objects using lenses.</li> <li>Locating positions of images formed by lenses.</li> <li>Observing the physical features of the lens.</li> </ul>	<ul style="list-style-type: none"> <li>Viewing different objects using the optical instruments.</li> <li>Examining small micro organisms using compound microscope.</li> <li>Determining angular magnification of an object.</li> </ul>	<ul style="list-style-type: none"> <li>Literacy; research and problem solving; communication; critical thinking; ICT and Digital competences; creativity and innovation</li> </ul>	<ul style="list-style-type: none"> <li>Literacy; research and problem solving; communication; critical thinking; ICT and Digital competences; creativity and innovation</li> </ul>	<ul style="list-style-type: none"> <li>Making of circuits.</li> <li>Perseverance and tolerance.</li> <li>Manipulating apparatus and equipment. Drawing conclusions and evaluating experimental procedure.</li> <li>Solving problems using kirchoff's law.</li> </ul>	<ul style="list-style-type: none"> <li>Identifying sources of energy in Rwanda</li> <li>Identifying features of renewable and non renewable sources.</li> <li>Modelling physical processes related to energy consumption.</li> </ul>



7 Energy degradation (dilapidation) and power generation	8 Projectile and uniform circular motion.	9 Universal gravitational field strength	10 Effects of electric and potential fields.	11 Application of thermodynamic laws.	12 General structure of the solar system
<ul style="list-style-type: none"> <li>Learners' group discussions about mechanisms of electrical energy production</li> <li>Learners to discuss about how to convert thermal energy into work.</li> <li>Search internet to find information on energy flow diagrams. Carry out an experiment to demonstrate the motion of a compass needle when brought near a horse shoe magnet.</li> </ul>	<ul style="list-style-type: none"> <li>Learners to throw a stone upwards and then at an angle and study the motion of the two.</li> <li>Tie a bob on a thread and swing it on a horizontal circle and then in a vertical circle. Release the bob and observe.</li> <li>Discuss in groups why a bicycle rider bends inwards when he is rounding a corner.</li> </ul>	<ul style="list-style-type: none"> <li>Learners to discuss in groups on what causes days and nights.</li> <li>Learners discuss in groups on what causes seasons in a year.</li> <li>In groups, learners discuss on how world wide communication is achieved with the help of satellites.</li> <li>Solve problems involving the law of universal gravitation.</li> </ul>	<ul style="list-style-type: none"> <li>Each learner to rub his pen with hair and attract small pieces of paper.</li> <li>Carry out an experiment to illustrate electric field lines.</li> <li>Visit a nearby place where there is a lightning.</li> </ul>	<ul style="list-style-type: none"> <li>Learners to inflate a balloon and release it.</li> <li>Learners to pump a bicycle tyre and then open it to feel the temperature of the air coming out.</li> <li>Learners to visit a garage and observe the difference between a diesel engine and a petrol engine.</li> <li>Learners working in groups to investigate changes in energy and work done for thermodynamic processes.</li> <li>Learners to visit a nearby shop where there is a refrigerator and discuss how it works.</li> <li>Learners to discuss the effect of heat engines on the climate.</li> </ul>	<ul style="list-style-type: none"> <li>Learners work in groups and investigate acceleration due to gravity on the earth's surface.</li> <li>Observe planets and stars using telescopes</li> <li>Learners to work in groups and discuss the number of planets in the universe and the characteristics of each.</li> <li>Learners to work in groups and discuss Kepler's law of planetary motion.</li> </ul>
<ul style="list-style-type: none"> <li>Analyzing energy degradation/dilapidation and power generation.</li> <li>Converting of thermo energy into work.</li> <li>Critical thinking.</li> </ul>	<ul style="list-style-type: none"> <li>Literacy; research and problem solving; communication; critical thinking; ICT and Digital competences; creativity and innovation</li> </ul>	<ul style="list-style-type: none"> <li>Literacy; research and problem solving; communication; critical thinking; ICT and Digital competences; creativity and innovation</li> </ul>	<ul style="list-style-type: none"> <li>Analysing electric and potential fields.</li> <li>Analysing the functioning of a lightning conductor (arrestor).</li> <li>Solve and analyse electric field and potential for uniform field.</li> </ul>	<ul style="list-style-type: none"> <li>Evaluating applications of first and second law of thermodynamics in real life.</li> <li>Solving problems related to petrol engine and diesel engine.</li> <li>Acquiring capacity to work with heat engines and reduce their effect on climate change.</li> </ul>	<ul style="list-style-type: none"> <li>Estimating the astronomical distances.</li> <li>Observing planets using telescopes.</li> <li>Distinguishing a star from a planet.</li> <li>Describing the structure of the solar system.</li> </ul>

Unit	1 Thin lenses	2 Simple and compound optical instruments	3. Moments and equilibrium of forces	4 Work energy and power	5 Kirchhoff's laws and electric circuits	6 Sources of energy in the world
Language practice	<ul style="list-style-type: none"> <li>• Proper use of terms in scientific terms.</li> <li>• Use of standard symbols to represent physical quantities and their units of measurement.</li> <li>• Integrating language( both foreign &amp; local in the unit.</li> </ul>	<ul style="list-style-type: none"> <li>• Proper use of scientific terms.</li> <li>• Integrating language( both foreign &amp; local in the unit</li> </ul>	<ul style="list-style-type: none"> <li>• Proper use of terms in scientific phenomena</li> <li>• Integrating language( both foreign &amp; local in the unit</li> <li>• Using different terms for different expressions.</li> </ul>	<ul style="list-style-type: none"> <li>• Proper use of terms in scientific phenomena</li> <li>• Integrating language( both foreign &amp; local in the unit</li> <li>• Using differed terms for differed expressions</li> </ul>	<ul style="list-style-type: none"> <li>• Use of scientific terms.</li> <li>• Use of standard symbols to represent physical quantities and their units of measurement.</li> </ul>	<ul style="list-style-type: none"> <li>• Use of standard symbols to represent physical quantities and their units of measurement.</li> </ul>
Vocabulary acquisition	<ul style="list-style-type: none"> <li>• Aperture, centre of curvature, radius of curvature, principal focus,</li> <li>• Principal axis, aberration</li> <li>• Refracting angle,</li> <li>• Critical angle, total internal reflection, dispersion, deviation of light.</li> </ul>	<ul style="list-style-type: none"> <li>• Visual angle, simple microscope, compound microscope, angular magnification, objective lens, eyepiece lens, eye ring, shortsighted ness, long sighted ness</li> </ul>	<ul style="list-style-type: none"> <li>• Moment of a force</li> <li>• Equilibrium of a body</li> <li>• Couple &amp; Torques</li> </ul>	<ul style="list-style-type: none"> <li>• Kinetic energy</li> <li>• Potential energy</li> <li>• Work energy Theorem</li> <li>• Strain energy</li> <li>• Collision and impulse.</li> </ul>	<ul style="list-style-type: none"> <li>• Terminal potential difference, electromotive force, resistors,</li> </ul>	<ul style="list-style-type: none"> <li>• Renewable and non renewable sources of power, fossil fuel, photo voltaic cells, solar panel,</li> </ul>
Numeracy	<ul style="list-style-type: none"> <li>• Measurement of length, proper substitution in the formulae, scale drawings, tabular presentation of data.</li> </ul>	<ul style="list-style-type: none"> <li>• Measurement of length, graphical representation, proper substitution in the formulae.</li> </ul>	<ul style="list-style-type: none"> <li>• Tabular representation of data.</li> </ul>	<ul style="list-style-type: none"> <li>• Deriving formulae for work- energy theorem, kinetic energy and potential energy.</li> <li>• Proper substitution in different formulae.</li> </ul>	<ul style="list-style-type: none"> <li>• Measuring currents and voltages.</li> <li>• Determining resistance</li> <li>• Proper use of Kirchhoff's laws.</li> <li>• Drawing graphs.</li> </ul>	<ul style="list-style-type: none"> <li>• Determining the quantity of energy generated.</li> </ul>
Study skills	<ul style="list-style-type: none"> <li>• Experimentation; Observation, tabular presentation of data</li> <li>• Conclusion</li> <li>• Scale drawing, discussing, listening.</li> </ul>	<ul style="list-style-type: none"> <li>• Observation, tabular presentation of data</li> <li>• Conclusion</li> <li>• Scale drawing, discussing, listening.</li> </ul>	<ul style="list-style-type: none"> <li>• Listening; speaking; reading; writing, and experimentation.</li> </ul>	<ul style="list-style-type: none"> <li>• Listening; speaking; reading; writing, and experimentation</li> </ul>	<ul style="list-style-type: none"> <li>• Experimentation,</li> <li>• Observation, Presentation of findings.</li> <li>• Comparison.</li> </ul>	<ul style="list-style-type: none"> <li>• Searching for information from internet.</li> <li>• Observation.</li> </ul>

7 Energy degradation (dilatation) and power generation	8 Projectile and uniform circular motion.	9 Universal gravitational field strength	10 Effects of electric and potential fields.	11 Application of thermodynamic laws.	12 General structure of the solar system
<ul style="list-style-type: none"> <li>Use of standard symbols to represent physical quantities and their units of measurement.</li> </ul>	<ul style="list-style-type: none"> <li>Proper use of terms in scientific phenomena.</li> <li>Integrating language( both foreign &amp; local in the unit).</li> <li>Using differed terms for differed expressions.</li> </ul>	<ul style="list-style-type: none"> <li>Proper use of terms in scientific phenomena.</li> <li>Integrating language( both foreign &amp; local in the unit).</li> <li>Using different terms for different expressions.</li> </ul>	<ul style="list-style-type: none"> <li>Use of standard symbols to represent physical quantities and their units of measurement.</li> </ul>	<ul style="list-style-type: none"> <li>Use of standard symbols to represent physical quantities and their units of measurement.</li> <li>Integrating language( both foreign &amp; local in the unit).</li> </ul>	<ul style="list-style-type: none"> <li>Use of standard symbols to represent physical quantities and their units of measurement.</li> <li>Proper use of scientific terms.</li> </ul>
<ul style="list-style-type: none"> <li>Energy.</li> <li>Energy degradation/ dilatation, rotating coils, energy flow diagrams</li> </ul>	<ul style="list-style-type: none"> <li>A projectile</li> <li>A trajectory</li> <li>Range</li> <li>Time of flight,</li> <li>Angular velocity, angular acceleration, banking.</li> </ul>	<ul style="list-style-type: none"> <li>Universe</li> <li>Centripetal force</li> <li>Circular path</li> <li>Gravitational field strength</li> <li>Gravitational potential energy</li> <li>Universal Gravitational constant</li> </ul>	<ul style="list-style-type: none"> <li>Coulomb, coulomb's law,</li> <li>Electric field, electric potential, gauss, theorem, lightning conductor(arrestor).</li> </ul>	<ul style="list-style-type: none"> <li>Thermodynamic systems, internal energy of a gas, isobaric change, isochoric change, adiabatic change, isothermal change.</li> <li>Heat engine, Carnot cycle, Otto cycle</li> </ul>	<ul style="list-style-type: none"> <li>Astronomical distances, constellation, phases of the moon, outer and inner planets, comets, meteorites, asteroids.</li> <li>Celestial coordinates.</li> <li>Zenith</li> </ul>
	<ul style="list-style-type: none"> <li>Calculating distances and speeds.</li> <li>Drawing velocity-time graphs.</li> </ul>	<ul style="list-style-type: none"> <li>Experimentation.</li> <li>Calculating force between two bodies.</li> <li>Solve mathematical problems.</li> <li>Find the relation between G and g.</li> </ul>	<ul style="list-style-type: none"> <li>Experimentation; observation.</li> <li>Finding the electric potential and field intensity.</li> </ul>	<ul style="list-style-type: none"> <li>Measurement of temperature proper substitution in the formulae, drawing p-v diagrams for different gas changes.</li> </ul>	<ul style="list-style-type: none"> <li>Calculating hour angle, zenith angle,</li> </ul>
<ul style="list-style-type: none"> <li>Searching information from internet.</li> <li>Presentation of group findings.</li> </ul>	<ul style="list-style-type: none"> <li>Listening; speaking; reading; writing, and experimentation.</li> </ul>	<ul style="list-style-type: none"> <li>Listening; speaking; reading; writing, and experimentation.</li> </ul>	<ul style="list-style-type: none"> <li>Experimentation, observation, analysing.</li> </ul>	<ul style="list-style-type: none"> <li>Experimentation; Observation, tabular presentation of data.</li> <li>Conclusion.</li> <li>Scale drawing, discussing, listening.</li> </ul>	<ul style="list-style-type: none"> <li>Observation presentation of data</li> <li>Conclusion</li> </ul>

Unit	1 Thin lenses	2 Simple and compound optical instruments	3. Moments and equilibrium of forces	4 Work energy and power	5 Kirchhoff's laws and electric circuits	6 Sources of energy in the world
Assessment	Experiments continuous Assessment exercises, summative Assessment at the end of the unit. Group activities	Experiments Revision exercises for continuous Assessment and summative Assessment. Group activities	Revision exercises provided. Group activities	Revision exercises provided. Group activities.	Revision exercises provided	Revision exercises provided
Learning outcome	<ul style="list-style-type: none"> <li>Appreciate the applications of lenses in every day life.</li> <li>Identify how to use the lenses effectively.</li> <li>Enjoy using lenses' equipment.</li> <li>Explain the defects of lenses and how they can be corrected.</li> <li>Explain the phenomenon of refraction by the prism.</li> <li>Explain the phenomenon of dispersion of light by the prism.</li> <li>Identify the application of total reflecting prisms.</li> </ul>	<p>Appreciate the use of optical instruments in daily life.</p> <p>Designing some optical instruments such as a lens camera and a compound microscope.</p> <p>Appreciate the working mechanisms of the instruments. Determine the magnifying power of an optical instrument.</p>	<ul style="list-style-type: none"> <li>Differentiating Vector from scalar Quantity.</li> <li>Resolving forces.</li> <li>Determine centre of gravity and mass.</li> <li>Stating conditions for a body to be in Equilibrium.</li> </ul>	<ul style="list-style-type: none"> <li>Differentiate work from energy.</li> <li>Appreciate importances of doing work.</li> <li>Appreciate The importances of having power.</li> <li>Relate work, power &amp; Energy.</li> <li>Appreciate principal of conservation of energy.</li> </ul>	<ul style="list-style-type: none"> <li>Apply Kirchhoff's laws to solve circuit problems.</li> <li>Acquire practical skills making simple circuits.</li> <li>Explain the sources of electric current, emf.</li> <li>Develop perseverance when dealing with electrical appliances.</li> <li>Identify the dangers of electric current.</li> </ul>	<ul style="list-style-type: none"> <li>Identify sources of energy in Rwanda</li> <li>Describe how to extract and create renewable and non renewable sources.</li> <li>Evaluate energy uses and availability in the world.</li> <li>Recognise and avoid the sources of energy associated with dangers.</li> </ul>

7 Energy degradation (dilatation) and power generation	8 Projectile and uniform circular motion.	9 Universal gravitational field strength	10 Effects of electric and potential fields.	11 Application of thermodynamic laws.	12 General structure of the solar system
<ul style="list-style-type: none"> <li>Revision exercises provided.</li> </ul>	<ul style="list-style-type: none"> <li>Revision exercises provided.</li> </ul>	<ul style="list-style-type: none"> <li>Revision exercises provided.</li> </ul>	<ul style="list-style-type: none"> <li>Revision exercises provided.</li> </ul>	<ul style="list-style-type: none"> <li>Continuous Assessment.</li> <li>Revision exercises and summative. Assessment at the end of the unit.</li> </ul>	<ul style="list-style-type: none"> <li>Revision exercises provided.</li> </ul>
<ul style="list-style-type: none"> <li>Explain mechanism of electrical energy production.</li> <li>Construct energy flow diagrams.</li> <li>Appreciate how the electrical energy produced by rotating coils in the magnetic fields.</li> <li>Recognise the value of energy transformation and its applications.</li> </ul>	<ul style="list-style-type: none"> <li>Appreciate the applications of projectiles in real life.</li> <li>Work out calculations involving projectiles &amp; derive different formulas.</li> </ul>	<ul style="list-style-type: none"> <li>Appreciate the movement of objects in the universe.</li> <li>Appreciate force of attraction between masses at a distance <math>r</math>.</li> <li>Solve problem about circular motion.</li> </ul>	<ul style="list-style-type: none"> <li>Appreciate the importance of a lightning conductor.</li> <li>Describe the functioning of a lightning conductor.</li> <li>Solve and analyse electric field and electric potential for uniform field.</li> <li>Be aware of the dangers caused by lightning.</li> </ul>	<ul style="list-style-type: none"> <li>Apply the laws to explain thermodynamic processes in heat engine.</li> <li>Apply the laws of thermodynamics to describe isothermal, isochoric, isobaric and adiabatic processes.</li> <li>Describe the impact of heat engines on climate.</li> <li>Solve problems related to carnot cycle, diesel engine and refrigerators.</li> </ul>	<ul style="list-style-type: none"> <li>Identify and explain scales for estimate astronomical distances.</li> <li>Distinguish a star from a planet.</li> <li>Appreciate the importance of orbital motion of the earth to human life.</li> <li>Explain the phenomenon of eclipse and explain phases of the moon.</li> <li>Identify celestial coordinates.</li> </ul>



# UNIT 1

## Thin Lenses

**Number of Lessons: 24**

**Learner's book pages 3-68**

**Key unit competence:** To be able to explain the properties of lenses and describe image formation by lenses.



### Learning objectives

Learners should be able to:

- explain physical features of thin lenses.
- state the types of lenses and explain their properties.
- differentiate between lenses and curved mirrors.
- explain the phenomenon of refraction of light by lenses.
- draw ray diagrams for formation of images by lenses.
- explain the defects of lenses and how they can be corrected.
- describe the daily applications of lenses.
- derive the lens equation from first principles.
- carry out experiments to determine the focal length of lenses.
- describe refraction through glass prisms.

This unit is to be taught in 24 periods, each of 40 minutes

Evaluation must be carried out in allocated time.

### Unit Breakdown

Serial number	Lesson title	Number of minutes	Periods
1	Types of lenses and their characteristics	80	2
2	Terms used in lenses, Refraction of light by lenses, Images formed by lenses	80	2
3	Ray diagrams and images formed by lenses	80	2
4	Thin lens formula (equation), the sign convention	80	2
5	Magnification, Power of the lens	80	2

Serial number	Lesson title	Number of minutes	Periods
6	Graphical determination of focal length of a convex lens	80	2
7	Determination of focal length of a concave lens	80	2
8	Combination of lenses, and effective focal length of the lens combination	80	2
9	Defects of lenses and their corrections, Refraction through glass prisms (introduction and terms associated with refraction through the prisms)	80	2
10	Determination of refractive index of the prism; Deviation of light by the prism, Minimum deviation, Determination of refractive index of a material of a glass prism using minimum deviation	80	2
11	Dispersion of light, Applications of total internal reflection by a prism	80	2
12	Problem solving related to combined thin lenses and refraction of light	80	2
	Total	960	24

### Introduction

Man has always had interest in observing things in a more detailed manner. Lenses or magnifying glasses, as they are sometimes called, have been used to observe objects.

People with poor eye sight use lenses to enable them see better, for example, use of reading glasses to enlarge prints, watch repairers and handset cell phone repairers also use lenses.

## Lesson 1: Types of lenses and their characteristics

Period 1: (40 Minutes)

### Material required for each group

Bi-convex lens, Plano-convex lens, bi- concave lens, plano-concave lens, and some eye glasses.

Step 1: Let the learners carry out the activities listed below and investigate the optical properties of lenses.



▶ **Activity 1 Page 5**

- Provide the learners with the lenses and eye glasses and let the learners examine the physical features of the lenses.
- Let the learners touch and feel the lenses.

Step 2: With the use of guided questions lead the learners to discuss that lenses are pieces of glasses with curved surfaces.

▶ **Activity 2 Page 7**

- Take the learners into a dark room.
- Divide them in groups of four and provide each group with a convex lens, a concave lens and a torch.
- Let the learners shine light on each mounted lens and observe the emergent rays.

Step 3: Using leading and guided questions help the learners develop the concept of a converging lens and a diverging lens from their observation.

**Lesson Flow (This is true for all lessons)**

Let the learners do activities in learner's book (if it is a mixed school, mix boys and girls).

Put learners in groups (select any number of learners depending on the size of the class) make sure that they work in harmony.

Help them in selecting their group leaders.

Recognise learners with special needs in group making. Encourage them to actively participate in their respective groups.

Move around the class guiding learners as they are performing the activity. In case of any assistance you can make bright learners to assist the weak ones.

Let the learners discuss their findings in their groups and finally present to the whole class.

Consolidate the lesson by developing and giving your ideas basing on learners' ideas.

### **Note**

Help the learners to work neatly and systematically.

### **Assessment criteria**

Learners may be assessed using the following methods;

- by asking them oral questions.
- making learners to work out activities.
- check and mark work of each learner.

The methods mentioned above can be varied. The use of a particular method depends on the size of the class, level of learners, availability of scholastic materials, time of the day and the moods of the learners.

### **References**

Learner's book 4 (Physics for Rwanda Secondary Schools Book 4)

Other available Physics books in the school library.

## **Lesson 2: Terms used in lenses**

---

Period 2: (80 Minutes)

Step 1: Provide the learners with both convex and concave lenses and let them carry out activities 2 to 7 in learner's book pages 7-11.

Let the learners carry out activities systematically and in order help them discover the terms relevant from each activity.

Put more emphasis on activities 6 and 7 since they lead to an understanding of the concepts of the principal focus and the focal length for they will be commonly applied.

Step 2: Explain terms as the activities are carried out by the learners. Pass through and guide the learners whenever the occasion demands.

Talk about the terms; principal axis, aperture, centre of curvature, radius of curvature, principal focus, focal length, and axis of the lens.

### **Images formed by lenses**

Step 1: Divide the learners into groups of four and provide each group with a lamp, a convex lens of focal length 10cm, a lens holder and a white sheet of paper preferably size A4.

Step 2: Instruct the learners to follow the procedures described in Activity 9 in the text book in order to investigate the nature of images formed by a convex lens when an object is placed at different positions on the principal axis.

Step 3: Guide the learners to discover that the nature of the image formed by a convex lens depends on the position of the object along the principal axis of the lens. Some images are larger, some are smaller than the object and others are same size as the object. All the images formed on the white sheet of paper are inverted. These are real images.

Step 4: Images formed by concave lenses.

Lead the learners, with the aid of a ray diagram to the conclusion that unlike a convex lens where the nature of the image depends on its position, a concave lens forms only virtual images.

### **Lesson Flow**

Let the learners carry out the activities in learner's book (if it is a mixed school, mix boys and girls).

Put learners in groups (select any number of learners depending on the size of the class) make sure that they work in harmony.

Help them in selecting their group leaders.

Recognise learners with special needs during group making. Encourage them to actively participate in their respective groups.

Move around the class guiding learners as they are performing the activities. In case of any assistance you can make bright learners to assist the weak ones.

Let the learners discuss their findings in their groups and finally present to the whole class.

Consolidate the lesson by developing and giving your ideas basing on learners' ideas.

### **Note**

Help the learners to work neatly and systematically.

### **Assessment criteria**

Learners may be assessed using the following methods;

- by asking them oral questions.
- making learners to work out activities.
- checking and marking work of each learner.

The methods mentioned above can be varied. The use of a particular method depends on the size of the class, level of learners, availability of scholastic materials, time of the day and the moods of the learners.

### **References**

Learner's book 4 (Physics for Rwanda Secondary Schools Book 4)

Other available Physics books in the school library.

## **Lesson 3: Ray diagrams and images formed by lenses**

---

Period 3: (80 Minutes)

Step 1: Provide the learners with graph papers and instruct them to carry out activity 12; learner's book page 19. Make sure learners have also completed activity 11.

Step 2: Explain the relevance of using two specific rays to locate the position of an image. Explain to the learners that many rays of light come from the object but all rays cannot be considered while drawing ray diagrams.

Step 3: Let the learners carry out activity 16 in learner's book on page 29.

Step 4: Give explanations where necessary.

Step 5: Learners carry out activity 13 in learner's book 4 on page 23.

### **Lesson Flow**

Let the learners carry out activities described in learner's book (if it is a mixed school, mix boys and girls).

Put learners in groups (select any number of learners depending on the size of the class) make sure that they work in harmony.

Help them in selecting their group leaders.

Recognise learners with special needs in group making. Encourage them to actively participate in their respective groups.

Move around the class guiding learners as they are performing the activity. In case of any assistance you can make bright learners to assist the weak ones.

Let the learners discuss their findings in their groups and finally present to the whole class.

Consolidate the lesson by developing and giving your ideas basing on learners' ideas.

**Note**

Help the learners to work neatly and systematically.

**Assessment criteria**

Learners may be assessed using the following methods;

- by asking them oral questions.
- making learners to work out activities.
- checking and marking work of each learner.

The methods mentioned above can be varied. The use of a particular method depends on the size of the class, level of learners, availability of scholastic materials, time of the day and the moods of the learners.

**References**

Learner's book 4 (Physics for Rwanda Secondary Schools Book 4)

Other available Physics books in the school library.

**Lesson 4: Thin lens formula (equation)**

---

Period 4: (80 Minutes)

Step 1: Instruct the learners to do activities 14 and 15 in the learner's book on page 24-25.

Step 2: Derivation of thin lens formula for a convex lens.

Guide the learners and use ray diagrams for several positions of the object, to derive the lens formula stating clearly all the assumptions made.

Assumptions are: the lenses are thin and rays of light fall on a lens at points close to the principal axis.

Using ray diagrams for several positions of the object, guide the learners to develop the lens' equation for concave lenses.

Step 3: Derivation of thin lens formula for a concave lens

Show the learners that for both cases of lenses, the lens formula holds.

### **The sign convention**

Step 1: Step by step, solve the example on page 29 in the learner's book.

Step 2: Let the learners do exercise on page 31.

Step 3: Through guided questioning, develop the concept that distances of real objects and real images are positive, and distances of virtual objects and images are negative.

Similarly, guide the learners to discover that the focal lens of a convex lens is positive and that of a concave lens is negative since their principal foci are real and virtual respectively.

### **Lesson Flow**

Let the learners carry out the activities in learner's book (if it is a mixed school, mix boys and girls).

Put learners in groups (select any number of learners depending on the size of the class) make sure that they work in harmony.

Help them in selecting their group leaders.

Recognise learners with special needs in group making. Encourage them to actively participate in their respective groups.

Move around the class guiding learners as they are performing the activity. In case of any assistance you can make bright learners to assist the weak ones.

Let the learners discuss their findings in their groups and finally present to the whole class.

Consolidate the lesson by developing and giving your ideas basing on learners' ideas.

**Note**

Help the learners to work neatly and systematically.

**Assessment criteria**

Learners may be assessed using the following methods;

- by asking them oral questions.
- making learners to work out activities.
- check and mark work of each learner.

The methods mentioned above can be varied. The use of a particular method depends on the size of the class, level of learners, availability of scholastic materials, time of the day and the moods of the learners.

**References**

Learner's book 4 (Physics for Rwanda Secondary Schools Book 4)

Other available Physics books in the school library.

**Lesson 5: Magnification**

---

Period 5: (80 Minutes)

Step 1: Instruct the learners to carry out activity 16 in learner's book on page 29.

Ask each learner to measure the heights of the object and the image.

Ask them to find the ratio of image height and object height.

By use of guided questions lead the learners to discover that the ratio obtained gives the number of times an image is larger than the object.

Step 2: Ask the learners to measure distances of object and image from the lens.

Ask them to find the ratio of image distance to the object distance from the lens.

Step 3: Guide the learners using thought provoking and guided questions to a conclusion that magnification can be determined from the ratio of image distance to object distance from the lens.

Guide the learners to discover that for both cases of lenses, the lens formula holds.

Step 4: Step by step and logically, solve the example on page 30 in the learner's book.

### **Power of the lens**

Step 1: Provide the learners with a convex lens of focal length 10cm and another of focal length 15cm, and let them carry out activity 18 in the learner's book page 33.

From the activity, and by use of thought provoking questions guide the learners to discover that the power of the lens depends on the focal length of the lens. The shorter the focal length the more powerful is the lens.

That is, power of the lens is the reciprocal of its focal length.

Step 2: Let the learners carry out activity 19 in the learner's book on page 34.

Step 3: Mark the learners' books after which make corrections with them.

Step 4: Put learners in groups of two and instruct them to do (group) activity 28 on page 45 in the learner's book.

### **Lesson Flow**

Let the learners carry out related activity in learner's book (if it is a mixed school, each group should have a balanced number of boys and girls).

Put learners in groups (select any number of learners depending on the size of the class) make sure that they work in harmony.

Help them in selecting their group leaders.

Recognise learners with special needs in group making. Encourage them to actively participate in their respective groups.

Move around the class guiding learners as they are performing the activity. In case of any assistance you can make bright learners to assist the weak ones.

Let the learners discuss their findings in their groups and finally present to the whole class.

Consolidate the lesson by developing and giving your ideas basing on learners' ideas.



**Note**

Help the learners to work neatly and systematically.

**Assessment criteria**

Learners may be assessed using the following methods;

- by asking them oral questions.
- making learners to work out activities.
- check and mark work of each learner.

The methods mentioned above can be varied. The use of a particular method depends on the size of the class, level of learners, availability of scholastic materials, time of the day and the moods of the learners.

**References**

Learner’s book 4 (Physics for Rwanda Secondary Schools Book 4)  
Other available Physics books in the school library.

**Lesson 6: Graphical determination of focal length of a convex lens**

Period 6: (80 Minutes)

Step 1: Provide each learner with the following: A convex lens, a torch, a screen with cross wires, a lens holder and a white sheet of paper.

Step 2: Instruct the learners to carry out activities 19 and 20 page 34.

Where necessary guide the learners by use of provoking questions to locate the position of the image.

Guide the learners to recall that, the distance from the lens to the screen is the focal length of the lens.

Step 3: Guide the learners in plotting graphs and finding the slope.

Step by step and by use of thought provoking and challenging questions guide the learners on how to determine the focal length, through making the object distance of the lens formula the subject of the formula.

Show that from .....

It follows that .....

It implies that .....

The above expression is an equation of a straight line and hence a plot of against  $\frac{u}{v}$  H is a straight lined graph and its slope is the focal length of the lens.

### **Lesson Flow**

Let the learners carry out related activity in learner's book (if it is a mixed school, each group should have a balanced number of boys and girls.

Put learners in groups (select any number of learners depending on the size of the class) make sure that they work in harmony.

Help them in selecting their group leaders.

Recognise learners with special needs in group making. Encourage them to actively participate in their respective groups.

Move around the class guiding learners as they are performing the activity. In case of any assistance you can make bright learners to assist the weak ones.

Let the learners discuss their findings in their groups and finally present to the whole class.

Consolidate the lesson by developing and giving your ideas basing on learners' ideas.

### **Note**

Help the learners to work neatly and systematically.

### **Assessment criteria**

Learners may be assessed using the following methods;

- by asking them oral questions.
- making learners to work out activities.
- check and mark work of each learner.

The methods mentioned above can be varied. The use of a particular method depends on the size of the class, level of learners, availability of scholastic materials, time of the day and the moods of the learners.

### **References**

Learner's book 4 (Physics for Rwanda Secondary Schools Book 4)  
Other available Physics books in the school library.

## Lesson 7: Determination of focal length of a concave lens

Period 7: (80 Minutes)

- Step 1: Provide learners with both a concave lens and concave mirror of known radius of curvature, a screen with cross wires and a torch.
- Step 2: Instruct the learners to carry out activity 21 in the learner's book page 36.
- Step 3: Through the use of guided questions remind the learners that a concave lens forms virtual images of real images, which cannot be seen on a screen. By using guided experimentation guide the learners to discover that in order to determine the focal length of a diverging lens there is need to form a virtual object for the diverging lens so that a real image is produced. Guide the learners to discover that this is achieved in the experiment by putting a concave mirror behind the lens so as to reflect back the diverging rays from the lens.

Similarly, when an object is placed at the principal focus of a concave mirror, the image is formed at the same position with it. Now, since the object and its image are coinciding, it means that they are at the centre of curvature of the mirror.

### Lesson Flow

Let the learners carry out a related activity in learner's book (if it is a mixed school, each group should have a balanced number of boys and girls).

Put learners in groups (select any number of learners depending on the size of the class) make sure that they work in harmony.

Help them in selecting their group leaders.

Recognise learners with special needs in group making. Encourage them to actively participate in their respective groups.

Move around the class guiding learners as they are performing the activity. In case of any assistance you can make bright learners to assist the weak ones.

Let the learners discuss their findings in their groups and finally present to the whole class.

Consolidate the lesson by developing and giving your ideas basing on learners' ideas.

### **Note**

Help the learners to work neatly and systematically.

### **Assessment criteria**

Learners may be assessed using the following methods;

- by asking them oral questions.
- making learners to work out activities.
- check and mark work of each learner.

The methods mentioned above can be varied. The use of a particular method depends on the size of the class, level of learners, availability of scholastic materials, time of the day and the moods of the learners.

### **References**

Learner's book 4 (Physics for Rwanda Secondary Schools Book 4)

Other available Physics books in the school library.

## **Lesson 8: Combination of lenses, and effective focal length of the lens combination**

Period 8: (80 Minutes)

Step 1: Provide learners with a compound microscope and ask them to identify the number of lenses it has.

Step 2: Provide the learners with two convex lenses one of focal length 15cm and the other of focal length 10cm and instruct them to carry out activities 22 and 23 in the learners' book on book page 37.

Guide the learners to discover that the light rays from a distant tree are parallel. Guide the learners to discover that the light rays meet at the focal plane of the lens as seen in 23 (a) and of the combination of the lenses as seen in 23 (b). Using thought provoking and guided questions lead the learners to conclude that the distance from the lens to the white sheet of paper is the focal length of the lens in (a) and the distance from the combination of the two lenses to the screen is the focal length of the combination.

Step 3: Derivation of the expression for the effective focal length of the combination of lenses.

Let the learners do the exercise on page 38 in the learner's book.

Step 4: Guide the learners to derive an expression for the effective focal length of a lens combination and to identify the applications of lens combinations.

### **Lesson Flow**

Let the learners carry out related activity in learner's book (if it is a mixed school, the number of boys and girls should be balanced).

Put learners in groups (select any number of learners depending on the size of the class) make sure that they work in harmony.

Help them in selecting their group leaders.

Identify learners with special needs in group making. Encourage them to actively participate in their respective groups.

Move around the class guiding learners as they are performing the activity. In case of any assistance you can make bright learners to assist the weak ones.

Let the learners discuss their findings in their groups and finally present to the whole class.

Consolidate the lesson by developing and giving your ideas basing on learners' ideas.

### **Note**

Help the learners to work neatly and systematically.

### **Assessment criteria**

Learners can be assessed using the following methods;

- by asking them oral questions.
- making learners to work out activities.
- check and mark work of each learner.

The methods mentioned above can be varied. The use of a particular method depends on the size of the class, level of learners, availability of scholastic materials, time of the day and the moods of the learners.

### **References**

- Learner's book 4 (Physics for Rwanda Secondary Schools Book 4)
- Other available Physics books in the school library.

## **Lesson 9: Defects of lenses and their corrections**

---

Period 9: (80 Minutes)

Step 1: Provide the learners with a ruler and a white sheet of papers.

Instruct the learners to do activity 24 in the learner's books on page 40.

Step 2: Provide the learners with a convex lens let them repeat the same experiment with a convex lens.

Step 3: Explain to the learners that what they have observed using a ruler can also be observed when the lens is used but because the lens converges light rays, the rays come closer to each other and the colours of the image overlap and are not clearly seen.

Talk about the two types of defects; the spherical and chromatic aberration.

Step 4: Using ray diagrams, describe how the defects can be minimised.

Explain to the learners that if they had an achromatic doublet, they could do the experiment about minimising chromatic aberration.

## **Refraction through glass prisms (introduction and terms associated with refraction through the prisms)**

---

Step 1: Ask learners if they have ever seen a glass prism.

Step 2: Provide the learners with an equilateral glass prism and instruct them to carry out activity 27 in learner's book page 44.

Step 3: Guide the learners to identify and define the terms i. e. angle of prism  $A$ , angle of incidence, angles of refraction on the two faces of the prism.

Using experimental method, guide the learners to discover the angle of minimum deviation.

- Step 4: Using experimental method, guide the learners to discover the angle of minimum deviation.
- Step 5: Step by step and logically solve the examples on page 46-48 in learner's book.
- Step 6: Set the learners solve the exercise that follows in the learner's book. Page 48.

### **Lesson Flow**

Let the learners carry out related activity in learner's book (if it is a mixed school, mix boys and girls).

Put learners in groups (select any number of learners depending on the size of the class) make sure that they work in harmony.

Help them in selecting their group leaders.

Recognise learners with special needs in group making. Encourage them to actively participate in their respective groups.

Move around the class guiding learners as they are performing the activity. In case of any assistance you can make bright learners to assist the weak ones.

Let the learners discuss their findings in their groups and finally present to the whole class.

Consolidate the lesson by developing and giving your ideas basing on learners' ideas.

### **Note**

Help the learners to work neatly and systematically.

### **Assessment criteria**

Learners may be assessed using the following methods;

- by asking them oral questions.
- making learners to work out activities.
- check and mark work of each learner.

The methods mentioned above can be varied. The use of a particular method depends on the size of the class, level of learners, availability of scholastic materials, time of the day and the mood of the learners.

## Lesson 10: Determination of refractive index of the prism

Period 10: (80 Minutes)

- Step 1: Guide the learners as they work through activity 32 in the learner's book on page 57.
- Step 2: Guide the learners on how to plot a graph and finding a scale for the graph.
- Step 3: Guide the learners to discover that the graph of a plot of  $\sin i$  against,  $\sin r$  is a straight line graph and the gradient represents the mean value of the refractive index of the prism material.

### Deviation of light by the prism

- Step 1: Provide the learners with a glass prism of refracting angle  $60^\circ$ , four optical pins, a white sheet of paper, a soft board and fixing pins
- Step 2: Instruct the learners to work through activity 30 in learner's book page 50.

Guide the learners to conclude that the total deviation of a ray by the prism is due to refraction at both faces of the prism and is the sum of the deviation of the ray due to refraction at the first surface and its deviation at the second surface.

- Step 3: Derive together with the learners an expression for deviation of light by the prism;  
 $D = (i_1 + i_2) - A$  by use of figure 1.39 in the learner's book.

### Minimum deviation

- Step 1: Provide the learners with a glass prism of refracting angle  $60^\circ$ , four optical pins, a white sheet of paper, a soft board and fixing pins.
- Step 2: Set the learners to work through activity 31 in learner's book page 51.
- Step 3: Together with the learners derive an expression for minimum deviation,  $D_{\min} = 2i - A$ . with the use of figure 1.43.



### **Determination of refractive index of a material of a glass prism using minimum deviation**

Step 1: Guide the learners to derive the relation between minimum deviation and the refractive index of the material;

$$n = \sin \frac{D_{\min} + A}{2} / \sin \frac{A}{2}$$

Step 2: Together with the learners use the derived formula to work through the example on page 54 in learner's book.

Step 3: Instruct learners to work through exercise on page 60 in learner's book.

### **Lesson Flow**

Let the learners carry out the related activity in learner's book (if it is a mixed school, each group should have a balanced number of boys and girls).

Put learners in groups (select any number of learners depending on the size of the class) make sure that they work in harmony.

Help them in selecting their group leaders.

Recognise learners with special needs in group making. Encourage them actively participate in their respective groups.

Move around the class guiding learners as they are performing the activities. In case of any assistance you can make bright learners to assist the weak ones.

Let the learners discuss their findings in their groups and finally present to the whole class.

Consolidate the lesson by developing and giving your ideas basing on learners' ideas.

### **Note**

Help the learners to work neatly and systematically.

### **Assessment criteria**

Learners may be assessed using the following methods;

- by asking them oral questions.

- making learners to work out activities.
- check and mark work of each learner.

The methods mentioned above can be varied. The use of a particular method depends on the size of the class, level of learners, availability of scholastic materials, time of the day and the moods of the learners.

### **References**

Learner's book 4 (Physics for Rwanda Secondary Schools Book 4)  
Other available Physics books in the school library.

## **Lesson 11: Dispersion of light**

---

Period 12: (80 Minutes)

Step 1: Ask learners to explain the meaning of the word dispersion. Pay attention to the learner's responses.

Guide the learners to arrive at the acceptable definition of dispersion.

Step 2: Provide learners with a plane mirror, a basin and water.

Step 3: Guide them to do activity 33 in the learner's book, page 58.

A band of seven colours is seen. This band of seven colours is called a spectrum. It is because the colours of white light separate as they pass through glass. Using thought provoking and leading question guide the learners to discover that the colours separate because glass has a different refractive index for each colour.

Step 4: Then provide them with a glass prism and guide them to carry out activity 34 in the learner's book page 58.

### **Applications of total internal reflection by a prism**

Step 1: Ask the learners to describe total internal reflection. Through questioning lead the learners to arrive at an acceptable definition of total internal reflection.

Step 2: Provide the learners with a glass prism, a white sheet of paper and ray-box (torch).

Step 3: Set the learners to do activity 35 in the learner's book page 59.

Step 4: Provide the learners with two right angled prisms and guide them to carry out activity 36 page 60.

Describe and explain to the learners how prisms are used in periscopes.

Step 5: Similarly, provide the learners with an equilateral prism and instruct them to carry out activity 37 on page 61.

Demonstrate to the learners how prisms are used in prism binoculars.

Step 6: Instruct learners to work through the critical thinking exercise on page 60 in learner's book.

**Answers to critical thinking exercise on page 61 in learner's book**

(a) In periscopes and prism binoculars, plane mirrors can be used but prisms are preferred because of the following reasons:

In the first place, a prism allows light to undergo total internal reflection and thus the images are formed by total internal reflection whereas a mirror allows light to both reflect and refract at its surface. So for a prism, all the light (100%) from the object is reflected but for a mirror some light is absorbed (about 95% is reflected) and thus a prism produces a brighter image than a mirror.

The silvering on the mirrors wears off with time but with prism no silvering is needed.

Some mirrors for, example, thick plane mirrors produce multiple images of one object because of reflections and refractions at the surfaces and inside the glass but a prism produces only one image.

(b) Diamonds are cut that way so as to make use of total internal reflection. The multiple reflections inside diamond make it bright.

**Lesson Flow**

Let the learners carry out the related activity in learner's book (if it is a mixed school, each group should have a balanced number of boys and girls).

Put learners in groups (select any number of learners depending on the size of the class) make sure that they work in harmony.

Help them in selecting their group leaders.

Recognise learners with special needs in group making. Encourage them to actively participate in their respective groups.

Move around the class guiding learners as they are performing the activities. In case of any assistance you can make bright learners to assist the weak ones.

Let the learners discuss their findings in their groups and finally present to the whole class.

Consolidate the lesson by developing and giving your ideas basing on learners' ideas.

### **Note**

Help the learners to work neatly and systematically.

### **Assessment criteria**

Learners can be assessed using the following methods;

- by asking them oral questions.
- making learners to work out activities.
- check and mark work of each learner.

The methods mentioned above can be varied. The use of a particular method depends on the size of the class, level of learners, availability of scholastic materials, time of the day and the moods of the learners.

### **References**

Learner's book 4 (Physics for Rwanda Secondary Schools Book 4)

Other available Physics books in the school library.

## **Lesson 12: Problem solving related to combined thin lenses and refraction of light**

---

Period 13: (80 Minutes)

Step 1: Provide learners with a microscope and instruct them to observe the microscope provided and try to identify the number of lenses it has got.

Let them attempt to count the lenses.

Ask them how many lenses they have seen.

Possible answer: The microscope comprises of two lenses.

Guide the learners to discover by use of thought provoking questions that many instruments such as microscopes and telescopes use a combination of lenses and these will be discussed in the next unit.

Step 2: Put learners in groups of four and ask them to discuss the uses of a combination of lenses.

Possible answer: Combining lenses increases the power to focus objects.

On top of the lenses being used in such optical instruments, combined lenses are used to minimize chromatic aberration for example an achromatic doublet which is a combination of convex lens and a concave lens.

Some spectacles are a combination of lenses. Such spectacles are used for reading.

Step 3: Set the learners to work through the example on page 56 in the learner's book

Step 4: Set the learners work through the exercise on page 62 in the learner's book.

### **Lesson Flow**

Let the learners carry out the related activity in learner's book (if it is a mixed school, each group should have a balanced number of boys and girls).

Put learners in groups (select any number of learners depending on the size of the class) make sure that they work in harmony.

Help them in selecting their group leaders.

Recognise learners with special needs in group making. Encourage them to actively participate in their respective groups.

Move around the class guiding learners as they are performing the activity. In case of any assistance you can make bright learners to assist the weak ones.

Let the learners discuss their findings in their groups and finally present to the whole class.

Consolidate the lesson by developing and giving your ideas basing on learners' ideas.

**Note**

Help the learners to work neatly and smartly.

**Assessment criteria**

Learners can be assessed using the following methods;

- by asking them oral questions.
- making learners to work out activities.
- check and mark work of each learner.

The methods mentioned above may be varied. The use of a particular method depends on the size of the class, level of learners, availability of scholastic materials, time of the day and the moods of the learners.

**References**

Learner's book 4 (Physics for Rwanda Secondary Schools Book 4)

Other available Physics books in the school library.

## UNIT 2

# Simple and compound optical instruments

**Number of Lessons: 18**

**Learner's book pages 71-122**

**Key unit competence:** By the end of the unit, the learner will be able to analyse the functioning of simple and compound optical instruments and determine their magnifying power.



### Learning objectives

---

Learners should be able to:

- describe an optical instrument.
- explain the physical features of a human eye.
- describe the image formation by the eye.
- identify the physical features of a simple and compound microscope.
- determine the angular magnification/ magnifying power of a simple and compound microscopes.
- explain the applications of simple and compound microscopes.
- differentiate between simple and compound microscopes.
- explain the operation of a lens camera and its application.
- explain the operation of a slide projector and its applications.
- identify the physical features of a telescope.
- identify different types of telescopes.
- explain the operation of telescopes.
- differentiate between telescopes and microscopes.
- identify the physical features of prism binoculars.

This unit is to be taught in 18 periods each of 40 minutes.

Evaluation must be done in allocated time.

### Unit Breakdown

Serial number	Lesson title	Number of minutes	Periods
1	Introduction to optical instruments and angular magnification	40	1
2	The human eye	40	1
3	Visual angle	40	1
4	Accommodation of the eye, defects of vision and their correction	40	1
5	A lens camera	40	1
6	The slide projector	40	1
7	The simple microscope	40	1
8	Simple microscope not in normal adjustment	40	1
9	compound microscope	40	1
10	Compound microscope not in normal use	40	1
11	Telescopes	40	1
12	Astronomical telescope not in normal use	40	1
13	Terrestrial telescope	40	1
14	Galileo Galilee, the scientist	40	1
15	Galilean telescope not in normal use	40	1
16	Reflecting telescopes	40	1
17	Cassegrain reflector telescope and coude reflector telescope	40	1
18	Prism binoculars	40	1
	Total	720	18

#### Introduction

Man has always had interest in exploring what is beyond things he observes using a naked eye. Optical instruments are very useful, for example in the study under microscope, lenses are used to magnify tiny organisms that may not be easily seen by the naked eye, and in telescope, lenses are used to magnify distant objects like the stars and moon.



## Lesson 1. Introduction to optical instruments and angular magnification

Period 1: (40 Minutes)

Step 1: Instruct learners to look around class and view the various objects in the class room.

**Let each learner write down what he/she has seen**

Step 2: Take the learners outside class and instruct them to observe distant objects around the school and let each learner write down what he/she has seen.

Pick some five learners at random to present to class their observations. Discuss the relevance of their observations.

Step 3: By use of challenging and thought provoking questions guide the learners to conclude that any device used to aid vision is called an optical instrument.

Guide the learners to discover that the instruments are categorised into two;

- (i) Simple optical instruments such as a lens camera, a slide projector and a simple microscope. These use only one lens to form an image of an object.
- (ii) Compound optical instruments which include compound microscope, telescopes and prism binoculars. These use a combination of lenses and prisms to form images of objects.

Step 4: Magnifying power or angular magnification of an optical instrument

Guide the learners to explain the concept of magnifying power of an optical instrument using the visual angles, Magnifying power.

Using leading questions, guide the learners to explain how the instruments use visual angles to view objects in a detailed manner.

### Lesson Flow

Let the learners carry out the related activity in learner's book (if it is a mixed school, balance the number of boys and girls in each group).

Put learners in groups (select any number of learners depending on the size of the class) make sure that they work in harmony.

Help them in selecting their group leaders.

Recognise learners with special needs in group making. Encourage them to actively participate in their respective groups.

Move around the class guiding learners as they are performing the activity. In case of any assistance you can make bright learners to assist the weak ones.

Let the learners discuss their findings in their groups and finally present to the whole class.

Consolidate the lesson by developing and giving your ideas basing on learners' ideas.

### **Note**

Help the learners to work neatly and systematically.

### **Assessment criteria**

Learners may be assessed using the following methods;

- by asking them oral questions.
- making learners to work out activities.
- check and mark work of each learner.

The methods mentioned above can be varied. The use of a particular method depends on the size of the class, level of learners, availability of scholastic materials, time of the day and the moods of the learners.

### **References**

Learner's book 4 (Physics for Rwanda Secondary Schools Book 4)  
Other available Physics books in the school library.

## **Lesson 2: The human eye**

---

Period 2: (40 Minutes)

Step 1: Group the learners in groups of two and guide them to do activity 2 in the learner's book page 73.

Step 2: Display a chart in class showing the parts of the eye.

By use of thought provoking and challenging questions guide the learners to explain the functions of each part of the eye as described in their book.

Step 3: Guide to the learners, using the knowledge of lenses, how an image is formed in the eye.

### **Lesson 3: Visual angle**

---

Period 3: (40 Minutes)

Step 1: Visual angle

Take the learners outside class to observe some distant plantation (It may be a forest or a banana plantation).

Ask them to take note of the heights of the objects observed.

Guide the learners to discover that visual angle is the angle the top of an object makes with the axis of the lens in the eye. Demonstrate how the size of the image depends on the visual angle.

Step 2: Put learners in groups of four and let them carry out activity 4 in learner's book page 76.

#### **Answer to question in activity 4**

The forest appears to have the same height because all the trees subtend the same angle to the eye and hence their apparent sizes on the retina are the same.

#### **Lesson Flow**

Let the learners carry out the related activity in learner's book (if it is a mixed school, balance the number of boys and girls in each group).

Put learners in groups (select any number of learners depending on the size of the class) make sure that they work in harmony.

Help them in selecting their group leaders.

Recognise learners with special needs in group making. Encourage them to actively participate in their respective groups.

Move around the class guiding learners as they are performing the activity. In case of any assistance you can make bright learners to assist the weak ones.

Let the learners discuss their findings in their groups and finally present to the whole class.

Consolidate the lesson by developing and giving your ideas basing on learners' ideas.

### Note

Help the learners to work neatly and systematically.

### Assessment criteria

Learners may be assessed using the following methods;

- by asking them oral questions.
- making learners to work out activities.
- check and mark work of each learner.

The methods mentioned above can be varied. The use of a particular method depends on the size of the class, level of learners, availability of scholastic materials, time of the day and the moods of the learners.

### References

Learner's book 4 (Physics for Rwanda Secondary Schools Book 4)

Other available Physics books in the school library.

## Lesson 4: Accommodation of the eye, defects of vision and their correction

Period 4: (40 Minutes)

Step 1: Instruct each learner to hold a book at an arm's length and then move it closer to one's face so that he/she can focus the words clearly without straining his/her eyes.

Let each learner approximate the distance between his/her eyes and the book.

Take learners outside class to look at the objects far from their school. Ask the learners to look at the farthest objects they can possibly see.

Ask each learner to write down the farthest object seen.

Pick four learners at random and ask each one of them to give a report.

Through the use of guided questions lead the learners to discover that people with normal vision can focus both near and distant objects. Lead them to conclude that this ability of the eye to see near and distant objects is called accommodation of the eye.

The near point of the eye is the nearest point that can be focused by the unaided eye. It is a closest distance that the 'normal' human eye can observe clearly; without any strain to the eye. It is called the least distance of distinct vision. The near point of a normal eye is 25cm.

The distance from a distant object to the eye is the far point of the eye. The far point of the eye is infinity.

Step 2: Ask learners why some people wear eye glasses.

Set the learners to discuss this question in groups of three.

Guide the learners to conclude that those people who put on different glasses have eye defects.

Step 3: Request each learner to hold a book at an arm's length and move the book towards one's face up to a point where the prints are read without the eye getting strained.

Ask them try to read the words on a chalkboard a distance far away from the classroom.

Find out from them if they are able to see clearly both near and distant objects?

Guide the learners to conclude that people with normal vision can clearly see near and distant objects. Those who clearly see near objects but cannot see distant objects are said to be short sighted. Those who see only distant objects are said to be long sighted.

Using ray diagrams, guide the learners to discuss the different types of defects; short sightedness, long sightedness, astigmatism and Presbyopia.

Step 4: Provide learners with lens spectacles; ones that are convex and the others concave.

Allow the learners touch the different spectacles and feel the difference.

Using guided questions lead the learners to discover which kind of defects the spectacles are used to correct.

Guide the learners to draw ray diagrams for the formation of images by the spectacles.

### **Lesson Flow**

Let the learners carry out the related activity in learner's book (if it is a mixed school, the number of boys and girls in each group should be balanced).

Put learners in groups (select any number of learners depending on the size of the class) make sure that they work in harmony.

Help them in selecting their group leaders.

Recognise learners with special needs in group making. Encourage them to actively participate in their respective groups.

Move around the class guiding learners as they are performing the activity. In case of any assistance you can make bright learners to assist the weak ones.

Let the learners discuss their findings in their groups and finally present to the whole class.

Consolidate the lesson by developing and giving your ideas basing on learners' ideas.

### **Note**

Help the learners to work neatly and systematically.

### **Assessment criteria**

Learners may be assessed using the following methods;

- by asking them oral questions.
- making learners to work out activities.
- check and mark work of each learner.

The methods mentioned above can be varied. The use of a particular method depends on the size of the class, level of learners, availability of scholastic materials, time of the day and the moods of the learners.

## **References**

Learner's book 4 (Physics for Rwanda Secondary Schools Book 4)  
Other available Physics books in the school Library.

## **Lesson 5: A lens camera**

---

Period 5: (40 Minutes)

Step 1: Provide the learners with a manila paper and wax paper. Guide the learners to do activity 10 in learner's book pages 82.

Ask the learners to describe in their own words the image they have observed? Is it upside down or right side up. Is it smaller or larger than the actual object? What type of image is it?

Using thought provoking questions guide the learners to discover that the device they have made is actually a pinhole camera.

Step 2: Ask the learners which instrument was used by person who took their photos as they were to register for the national examination.

Ask the learners what they nowadays use to take photographs.

Guide the learners, with the help of leading questions, to conclude that they actually use a lens camera to take pictures.

Step 3: Using the box in step 1, let the learners carry out activity 12 on page 83 in learner's book.

Step 4: Try to get a camera and bring to the learners to see and touch. You may even take their photos.

Explain to the learners its mode of operation. Talk about the functions of the parts; The diaphragm, shutter, film, and the lens.

Step 5: Image formation by a lens camera.

Provide the learners with a convex lens and guide them to do activity 13 in the learner's book page 84. Ask the learners to explain and in their own words the type of angle formed. The image formed is inverted, smaller than the object and coloured if the object is coloured.

Step 6: In groups of four, set the learners discuss the differences between the lens camera and the human eye.

### **Lesson Flow**

Let the learners carry out the related activity in learner's book (if it is a mixed school, the number of boys and girls in each group should be balanced).

Put learners in groups (select any number of learners depending on the size of the class) make sure that they work in harmony.

Help them in selecting their group leaders.

Recognise learners with special needs in group making. Encourage them to actively participate in their respective groups.

Move around the class guiding learners as they are performing the activity. In case of any assistance you can make bright learners to assist the weak ones.

Let the learners discuss their findings in their groups and finally present to the whole class.

Consolidate the lesson by developing and giving your ideas basing on learners' ideas.

### **Note**

Help the learners to work neatly and systematically.

### **Assessment criteria**

Learners can be assessed using the following methods;

- by asking them oral questions.
- making learners to work out activities.
- check and mark work of each learner.

The methods mentioned above can be varied. The use of a particular method depends on the size of the class, level of learners, availability of scholastic materials, time of the day and the moods of the learners.

### **References**

Learner's book 4 (Physics for Rwanda Secondary Schools Book 4)

Other available Physics books in the school library.



## **Lesson 6: The slide projector**

---

Period 6: (40 Minutes)

- Step 1: Ask learners if they have ever watched a cinema. Ask them if the pictures were large or small.
- Step 2: If possible let the learners have access to the projector, let them touch and guide them to operate it.

By using leading questions, guide the learners to describe a projector. It is a device used to throw on a screen a magnified image of a film or a transparent slide. It produces a magnified real image of an object.

With the help of challenging and thought provoking questions lead the learners to discover how it operates, its main parts; the illumination system, projection lens and the screen.

- Step 3: Together with the learners, work through the example on page 88 in learner's book.

Set the learners work through the exercise on page 89 in the learner's book.

Step 3: Provide the learners with 2 convex lenses, a slide, a white sheet of paper, a torch and guide them to carry out activity 17 in the learner's book page 89.

### **Lesson Flow**

Set the learners do the related activity in learner's book (if it is a mixed school, the number of boys and girls in each group should be balanced).

Put learners in groups (select any number of learners depending on the size of the class) make sure that they work in harmony.

Help them in selecting their group leaders.

Recognise learners with special needs in group making. Encourage them to actively participate in their respective groups.

Move around the class guiding learners as they are performing the activity. In case of any assistance you can make bright learners to assist the weak ones.

Let the learners discuss their findings in their groups and finally present to the whole class.

Consolidate the lesson by developing and giving your ideas basing on learners' ideas.

### **Note**

Help the learners to work neatly and systematically.

### **Assessment criteria**

Learners may be assessed using the following methods;

- by asking them oral questions.
- making learners to work out activities.
- check and mark work of each learner.

The methods mentioned above can be varied. The use of a particular method depends on the size of the class, level of learners, availability of scholastic materials, time of the day and the moods of the learners.

### **References**

Learner's book 4 (Physics for Rwanda Secondary Schools Book 4)

Other available Physics books in the school library.

## **Lesson 7: The simple microscope**

---

Period 7: (40 Minutes)

Step 1: Provide the learners with a hand lens and instruct them to do activities 18 and 19 in the learner's book page 89 and 90.

Guide the learners to explain that a magnifying glass consists of a thin converging lens and it is used to view very small organisms or parts of organisms which cannot be easily seen by the naked eye. It forms a virtual, upright, magnified image of an object placed between the lens and its principal focus.

Step 2: Guide the learners to draw a ray diagram depicting the formation of an image by a simple microscope

Give learners instructions in activity 21 on page 91.

Step 3: Simple microscope in normal adjustment:

Using the same hand lens, let the learners carry out activity 22 in the learner's book page 92.

Using guided questions lead the learners to explain when the microscope can be in normal adjustment and when it is not in normal adjustment. In normal adjustment, the final image is at the near point while when it is not in normal adjustment, the final image is at infinity.

Step 4: Guide the learners to derive expressions for angular magnification of a simple microscope when in normal adjustment.

Step 5: Together with the learners, work through the example on page 95 in learner's book.

### **Lesson Flow**

Let the learners carry out the related activity in learner's book (if it is a mixed school, the number of boys and girls in each group should be balanced).

Put learners in groups (select any number of learners depending on the size of the class) make sure that they work in harmony.

Help them in selecting their group leaders.

Recognise learners with special needs in group making. Encourage them to actively participate in their respective groups.

Move around the class guiding learners as they are performing the activity. In case of any assistance you can make bright learners to assist the weak ones.

Let the learners discuss their findings in their groups and finally present to the whole class.

Consolidate the lesson by developing and giving your ideas basing on learners' ideas.

### **Note**

Help the learners to work neatly and systematically.

### **Assessment criteria**

Learners may be assessed using the following methods;

- by asking them oral questions.
- making learners to work out activities.
- check and mark work of each learner.

The methods mentioned above can be varied. The use of a particular method depends on the size of the class, level of learners, availability of scholastic materials, time of the day and the moods of the learners.

### References

Learner's book 4 (Physics for Rwanda Secondary Schools Book 4)

Other available Physics books in the school Library.

## Lesson 8: Simple microscope not in normal adjustment

Period 8: (40 Minutes)

Step 1: Using the previous knowledge in lesson 7, draw a ray diagram and guide the learners to derive an expression for the magnifying power of a simple microscope when not in normal adjustment.

Step 2: Set the learners work through the exercise on page 95 in learner's book.

Step 3: Uses of a compound microscope.

Divide the learners into groups of four and let them carry out group activities 24 and 25 on page 96 in the learner's book. Let each group choose a leader to present their findings.

Step 4: Provide learners with learner's books and let them open on page 96, observe what is being done in activity 26.

Consolidate the learners' responses and lead them to mention the uses of a magnifying glass.

### Lesson Flow

Let the learners carry out the related activity in learner's book (if it is a mixed school, the number of boys and girls in each group should be balanced).

Put learners in groups (select any number of learners depending on the size of the class) make sure that they work in harmony.

Help them in selecting their group leaders.

Recognise learners with special needs in group making. Encourage them to actively participate in their respective groups.

Move around the class guiding learners as they are performing the activity. In case of any assistance you can make bright learners to assist the weak ones.

Let the learners discuss their findings in their groups and finally present to the whole class.

Consolidate the lesson by developing and giving your ideas basing on learners' ideas.

### **Note**

Help the learners to work neatly and systematically.

### **Assessment criteria**

Learners may be assessed using the following methods;

- by asking them oral questions.
- making learners to work out activities.
- check and mark work of each learner.

The methods mentioned above can be varied. The use of a particular method depends on the size of the class, level of learners, availability of scholastic materials, time of the day and the moods of the learners.

### **References**

Learner's book 4 (Physics for Rwanda Secondary Schools Book 4)  
Other available Physics books in the school library.

## **Lesson 9: Compound microscope**

---

Period 9: (40 Minutes)

Step 1: Ask the learners to describe, each in his/her own words, a compound microscope.

Provide the learners with two lenses of focal lengths 5cm and 10cm together with a half metre ruler and some plasticine.

Let the learners arrange the apparatus as in activity 29 on page 98 in learner's book.

Let the learners observe some objects using the above arrangement.

Using guided and thought provoking questions lead the learners to discover that by arranging the lenses as above, they have actually made a compound microscope. A compound microscope is used to view very small organisms that cannot be seen using our naked eyes for example micro organisms.

Step 2: Formation of image in a compound microscope:

Using a ray diagram, guide the learners to discover how the microscope forms an image.

A compound microscope consists of two convex lenses of short focal lengths referred to as the objective and the eye piece. The objective is nearest to the object and the eye piece is nearest to the eye of the observer.

The object to be viewed is placed just outside the focal point (at a distance just greater than the focal length) of the objective lens. This objective lens forms a real, magnified, inverted image at a point inside the principal focus of the eye piece. This image acts as an object for the eye piece and it produces a magnified virtual image. So the viewer, looking through the eye piece sees a magnified virtual image of a picture formed by the objective i. e of the real image.

Step 3: Compound microscope in normal adjustment:

Provide learners with a compound microscope and a bird's feather and guide the learners to do activity 30 in the learner's book, page 100.

Guide the learners to conclude that by observing clearly without straining the eyes, a compound microscope is in normal adjustment. The compound microscope is in normal adjustment when the final image is formed at the near point (least distance of distinct vision),  $D$  of the eye.

Guide the learners to draw a ray diagram for the formation of an image of a compound microscope when in normal adjustment( use) and derive together with the learners an expression for its angular magnification.

Step 4: Provide learners with Microscope, Jar of pond water, Slide, Cover slip, Dropper and instruct them to do activity 31 page 104.

### **Lesson 10: Compound microscope not in normal use**

---

Period 10: (40 Minutes)

Step 1: Using the knowledge in lesson 9 and by use of leading questions guide the learners to discover that the microscope is not in normal adjustment if the final image is formed at infinity.

Step 2: Using a ray diagram, guide the learners to derive an expression for the angular magnification of the microscope not in normal use.

Step 3: Guide the learners and work out the example on page 104 in the learner's book.

### **Lesson 11: Telescopes**

---

Period 11: (40 Minutes)

Step 1: Ask learners why they are not able to see the planets during the night.

Ask them if they have ever heard of an instrument called a telescope.

Guide the learners to explain why our eyes cannot be able to see distant objects such as planets. Telescopes are instruments used to view distant objects such as stars and other heavenly bodies. Distant objects are difficult to see because light from them has spread out by the time it reaches the eyes, and since our eyes are too small to gather much light.

There are two kinds of telescopes; refracting telescopes and reflecting telescopes.

Step 2: Refracting telescopes:

Group the learners and provide each group with a convex lens of focal length 5cm and another of focal length of 20cm.

Guide them to carry out activity 33 in learner's book page 106.

By use of thought provoking and guided questions lead the learners to discover that the above lens combination is a refracting telescope. Guide them to conclude that it is called a refracting

telescope because it forms an image of the object by refracting light. Therefore, Refracting telescopes use lenses and they form images by refraction of light. There are different types of refracting telescopes; an astronomical telescope, the terrestrial telescope and the Galilean telescope.

Ask the learners to explain in their own words some telescope is named an astronomical telescope. It is called so because it is the one commonly used by astronomers.

Astronomical telescope in normal adjustment:

Provide to each of the groups formed above with a convex lens of focal length 5cm and another of focal length 20cm.

Let the learners carry out activity 34 in learner's book page 105.

Guide the learners to discover that when the eyes are relaxed, the image is at infinity and the telescope is in normal adjustment. Therefore, an astronomical telescope is in normal adjustment when the final image is formed at infinity.

Step 3: Guide the learners to derive an expression for magnifying power of an astronomical telescope using a ray diagram.

Step 4: Together with your students, work through the example on page 109.

Set the learners to work through the exercise on page 110 learners' books.

## **Lesson 12: Astronomical telescope not in normal use**

Period 12: (40 Minutes)

Step 1: Arrange the learners into groups of four and let them carry out activity 35 in learner's book page 109.

Guide the learners to discover that for a telescope not in normal adjustment, the image is seen in detail but the telescope is not in normal adjustment (use) because the eyes are strained.

Step 2: Guide the learners to derive an expression for angular magnification for an astronomical telescope not in normal use.



### Lesson 13: Terrestrial telescope

---

Period 13: (40 Minutes)

Step 1: Group the learners and provide each group with three convex lenses of focal lengths 5cm, 10cm and 20cm.

Instruct them to carry out activity 36 on page 111 in the learner's book using the knowledge of activity 30.

Step 2: By the use of thought provoking and guided questions lead the learners to discover that what they have made is a terrestrial telescope. An astronomical telescope produces an inverted image, so it is not suitable for viewing objects on the earth. It is suitable for viewing stars and other heavenly bodies. A terrestrial telescope provides an erect image and this makes it suitable to view objectives on the earth.

The third lens between the objective and eyepiece is the erecting lens. The angular magnification of the telescope is similar to that of the astronomical telescope.

Step 3: In groups of four, let the learners discuss the advantages and disadvantages of a terrestrial telescope over an astronomical telescope.

The advantage a terrestrial telescope has over an astronomical telescope is that it produces an upright image.

However, the telescope is so long. It is much longer than other kinds of refracting telescopes. Its length is given by  $f_o + f_e + 4f$ .

The erecting lens also reduces the intensity of light emerging through the eye piece which makes the final image faint.

### Lesson 14: Galileo Galilee, the scientist

---

Period 14: (40 Minutes)

Ask the learners if they have ever heard of a scientist named Galileo Galilee.

Step 1: If some have ever heard of this scientist, ask them to explain what he is known for?

Guide them to recognise that Galileo was a great scientist well known for his discoveries in astronomy. He made a telescope and gave it his name Galilean telescope.

Step 2: Group the learners and provide each group with a concave lens of focal length and a convex lens of focal length 20cm and guide them to carry out activity 39 in the learner's book page 113.

By use of guided questions lead the learners to discover that the above lens combination is a Galilean telescope. A Galilean telescope consists of an objective lens which is a convex lens of long focal length and an eye piece which is a concave lens of short focal length.

Step 3: Galilean telescope in normal adjustment.

Guide the learners to derive expressions for angular magnification for a Galilean telescope in normal.

Guide them to conclude that a Galilean telescope has a small field of view and its eye ring is virtual (since the eye piece is concave) that is, it is between the lenses and so inaccessible to the eye.

### **Lesson 15: Galilean telescope not in normal use**

Period 15: (40 Minutes)

Step 1: Ask the learners to describe when we say that a Galilean telescope is not in normal use.

Step 2: Guide the learners to derive an expression for the angular magnification of the telescope when not in normal use.

Step 3: Arrange the learners in groups of five and let each group carry out activity 40 in the learner's book page 115.

Guide the learners with the help of challenging and thought provoking questions to conclude that unlike in an astronomical telescope where the final image is inverted, the final image formed in a Galilean telescope is erect. The telescope is also shorter than astronomical telescope and hence portable. The distance between the lenses is given by  $f_o - f_e$ .

## Lesson 16: Reflecting telescopes

Period 16: (40 Minutes)

### Step 1: Introduction

Locate a nearby place where there is a communications satellite dish or a digital television dish and take your learners to the place and let them observe the dish. To describe the possible uses of the dish that they are looking at.

From their responses, lead them to develop conclusions that reflecting telescopes use concave dishes to focus distant objects. Reflecting telescopes consist of a large concave mirror of long focal length as their objective. There are three kinds of reflector telescopes, all named after their inventors, the Newtonian reflecting telescope, Cassegrain reflector telescope and Coude reflector telescope.

Step 2: Using a ray diagram, ask your learners to explain how Newtonian reflecting telescope works.

Step 3: By using guided questions, lead the learners to conclude that the angular magnification for the telescope is similar to that of an astronomical telescope.

### Lesson Flow

Let the learners carry out the related activity in learner's book (if it is a mixed school, the number of boys and girls in each group should be balanced).

Put learners in groups (select any number of learners depending on the size of the class) make sure that they work in harmony.

Help them in selecting their group leaders.

Recognise learners with special needs during group making. Encourage them to actively participate in their respective groups.

Move around the class guiding learners as they are performing the activity. In case of any assistance you can make bright learners to assist the weak ones.

Let the learners discuss their findings in their groups and finally present to the whole class.

Consolidate the lesson by developing and giving your ideas basing on learners' ideas.

### **Note**

Help the learners to work neatly and systematically.

### **Assessment criteria**

Learners may be assessed using the following methods;

- by asking them oral questions.
- making learners to work out activities.
- check and mark work of each learner.

The methods mentioned above can be varied. The use of a particular method depends on the size of the class, level of learners, availability of scholastic materials, time of the day and the moods of the learners.

### **References**

Learner's book 4 (Physics for Rwanda Secondary Schools Book 4)

Other available Physics books in the school library.

## **Lesson 17: Cassegrain reflector telescope and Coude reflector telescope**

Period 17: (40 Minutes)

Step 1: Using a ray diagram, ask your learners to describe the structure and mode of operation of a Cassegrain reflector telescope.

Step 2: With the help of guided and thought provoking questions lead the learners to explain how the Newtonian telescope and Cassegrain reflector telescope are combined to make a Coude reflector telescope. Guide the learners to conclude that a combination is better in a way that the plane and convex mirrors used in reflecting telescopes are used to bring the light to a more convenient focus where the image can be photographed and magnified several times by the eye piece for observation.

Step 3: Arrange the learners in groups of five and set each group to carefully study the figures in the learner's book page 116, 117 and 118.

Let the group leaders present the views of their respective groups.

Using various questioning techniques guide the learners to consolidate their responses into:

The reflecting telescopes are free from chromatic aberration since no refraction occurs.

The image formed is brighter than in refracting telescopes where there is some loss of light during refraction at the lens surfaces.

Spherical aberration can be eliminated by using a parabolic mirror instead of a spherical mirror as an objective.

They have a power because of higher ability to distinguish two closely related objects because of the large diameter of the parabolic mirror. We say that they have a high resolving power.

They are easier to construct since only one surface requires to be grounded.

### **Lesson Flow**

Let the learners carry out the related activity in learner's book (if it is a mixed school, the number of boys and girls in each group should be balanced).

Put learners in groups (select any number of learners depending on the size of the class) make sure that they work in harmony.

Help them in selecting their group leaders.

Recognise learners with special needs during group making. Encourage them also participate in their respective groups.

Move around the class guiding learners as they are performing the activity. In case of any assistance you can make bright learners to assist the weak ones.

Let the learners discuss their findings in their groups and finally present to the whole class.

Consolidate the lesson by developing and giving your ideas basing on learners' ideas.

### **Note**

Help the learners to work neatly and systematically.

### Assessment criteria

Learners may be assessed using the following methods;

- by asking them oral questions.
- making learners to work out activities.
- check and mark work of each learner.

The methods mentioned above can be varied. The use of a particular method depends on the size of the class, level of learners, availability of scholastic materials, time of the day and the moods of the learners.

### References

Learner's book 4 (Physics for Rwanda Secondary Schools Book 4)

Other available Physics books in the school Library.

## Lesson 18: Prism binoculars

---

Period 18: (40 Minutes)

Step 1: Ask the learners to mention the devices that tourists and scientists used in order to observe the behaviour of distant animals in the game parks.

Using the learners' responses tourists and scientists use prism binoculars to focus on the birds and other wild life of interest in the game parks.

Step 2: Ask learners to state some applications of total internal reflection.

Using leading and thought provoking questions build from their responses the structure and mode of operation of prism binoculars.

Use a ray diagram to explain the formation of an image by a prism binocular.

Step 3: In groups of three, let the learners discuss why prisms are preferred to plane mirrors in prism binoculars.

### Lesson Flow

Let the learners carry out the related activity 40 in learner's book page 115 (if it is a mixed school, the number of boys and girls should be balanced).

Assign the learners in groups (select any number of learners depending on the size of the class) make sure that they work in harmony.

Help them in selecting their group leaders.

Recognise learners with special needs during group making. Encourage them to actively participate in their respective groups.

Move around the class guiding learners as they are performing the activity. In case of any assistance you can make bright learners to assist the weak ones.

Let the learners discuss their findings in their groups and finally present to the whole class.

Consolidate the lesson by developing and giving your ideas basing on learners' ideas.

### **Note**

Help the learners to work neatly and systematically.

### **Assessment criteria**

Learners may be assessed using the following methods;

- by asking them oral questions.,
- making learners to work out activities,
- check and mark work of each learner.

The methods mentioned above can be varied. The use of a particular method depends on the size of the class, level of learners, availability of scholastic materials, time of the day and the moods of the learners.

### **References**

Learner's book 4 (Physics for Rwanda Secondary Schools Book 4)

Other available Physics books in the school library.

## UNIT 3

# Moments and Equilibrium of Bodies

**Number of Lessons: 19**

**Learner's book pages 125-154**

**Key unit competence:** To be able to explain the principle of moments and apply it to the equilibrium of a body.



### Learning objectives

---

Learners should be able to:

- distinguish a vector and a scalar quantity.
- analyse the forces that keep a body in equilibrium.
- manipulate the resultant force as a vector sum.
- analyse free body diagrams.
- analyse diagrams of coplanar forces.
- locate the Centre of gravity of a flat object.
- solve problems involving vectors and scalars.
- solving problems involving moments and equilibrium of bodies.
- identify the application of vectors and scalars in life.
- recognise the various applications of the principle of moments on daily activities.
- describe areas of application of equilibria of forces in life.

This unit will be taught in 19 lessons, each of 40minutes.

Evaluation will be carried out during allocated time.



### Unit Breakdown

Serial number	Lesson title	Number of minutes	Periods
1	Force as a vector	80	2
2	Moment of force about a point (Principle of moments)	120	3
3	Types of equilibrium	40	2
4	Conditions for equilibrium of a body about an axis.	40	1
5	Stevinus proof	40	1
6	Forces in equilibrium	80	2
7	Free body diagrams	40	1
8	Couples and torques	80	2
9	Equilibrium of coplanar forces	80	2
10	Archimedes principle of lever	80	2
11	Equilibrium of moment of forces (Center of gravity and total weight)	120	2
	Total	760	19

### Lesson 1: Scalar and Vector quantities & Force as a vector

Period 1: (80 Minutes)

#### Introduction

Remember that learners studied this unit in O'level. Ask them if there is anything they know about this unit.

Leading and thought provoking questions, develop the concepts of scalar and vector quantities using real life examples. Time, distance travelled by a learner from home to school, Amount of money spent per day etc.

Guide the learners to discover that Force is a vector.

Instruct the learners to list down examples of scalar quantities and vector quantities.

### Lesson Flow

- Let the learners carry out activity 1 on page 126 in learner's book (if it is a mixed school, the number of boys and girls in each group should be balanced).
- Put learners in groups (select any number of learners depending on the size of the class) make sure that they work in harmony.
- Help them in selecting their group leaders.
- Recognise learners with special needs in group making. Encourage them to actively participate in their respective groups.
- Move around the class guiding learners as they are performing the activity. In case of any assistance you can make bright learners to assist the weak ones.
- Let the learners discuss their findings in their groups and finally present to the whole class.
- Consolidate the lesson by developing and giving your ideas basing on learners' ideas.

### Note

Help the learners to work neatly and systematically and they should always put units.

### Assessment criteria

Learners may be assessed using the following methods;

- by asking them oral questions.
- making learners to work through the activities on page 126-128 (Activity 2 page 126 and Quick check page 126).
- check and mark work of each learner.

The methods mentioned above can be varied. The use of a particular method depends on the size of the class, level of learners, availability of scholastic materials, time of the day and the moods of the learners.

### Solutions to group work on page 128-129

Question	Answer
1	C
2	B
3	B
4	D

Question	Answer
5	A
6	C
7	C
8	B
9	C
10	D

### References

Learner's book 4 (Physics for Rwanda Secondary Schools Book 4)

Other available Physics books in the school library.

## Lesson 2: Moment of force about a point and principle of moments

Period 2: (120 Minutes)

Remember that learners studied this unit in O'level. Ask them if there is anything they know about this part.

Using challenging and thought provoking questions guide the learners to define the moment of force about a point and its applications in real life.

By use of leading questions lead the learners to recognise the importance of these concepts in physics.

Request the learners to list down examples of the application of the concept in real life.

### Lesson Flow

- Let the learners carry out activity 4 on page 129 in learner's book (if it is a mixed school, the number of boys and girls in each group should be balanced).
- Put learners in groups (select any number of learners depending on the size of the class) make sure that they work in harmony.
- Help them in selecting their group leaders.
- Recognise learners with special needs in group making. Encourage them to actively participate in their respective groups.

- Move around the class guiding learners as they are performing the activity. In case of any assistance you can make bright learners to assist the weak ones.
- Let the learners discuss their findings in their groups and finally present to the whole class.
- Consolidate the lesson by developing and giving your ideas basing on learners' ideas.

### Assessment criteria

Learners may be assessed using the following methods;

- by asking them oral questions.
- making learners to work out the activities on pages 126 - 131.
- check and mark work of each learner.

The methods mentioned above can be varied. The use of a particular method depends on the size of the class, level of learners, availability of scholasti

c materials, time of the day and the moods of the learners.

### Additional content

Torque is the product of force and perpendicular distance

We define the **torque**  $t$  acting on the body from:  $t = F \times d \times \sin\alpha$ . The perpendicular distance of the line of action of the force from the axis of rotation is called the **moment arm** of the force.

- The S.I unit of torque is *Newton-meter* [Nm] or *meter-newton* [nM]

### Couple of force

Couple is defined as a pair of forces acting on a body which are equal in magnitude and which are anti-parallel.

A **couple**  $C$  consists of two equal and opposite parallel forces whose lines of action do not coincide. It always tends to change (**Refer to learner's book for explanation on forces pages 131**)

Examples include the handle of a bicycle.

**Note**

With learners, investigate how forces (couple of force) brings about rotation using a bicycle

**Parallelogram of forces**

Refer to Learner's book 4 for notes and explanations on Pages 132-133.

**Equilibrium of coplanar forces**

The following points will help learners to solve problems that involve a body acted on by three co-planar forces.

- a) The line of action of three forces must all pass through the same point.
- b) The principle of moments: The sum of all clock-wise moments about any point must have the same magnitude as the sum of all anti-clock wise moments about the same point

**Center of gravity**

The *center of gravity* is the average location of the weight of an object. Refer to learner's book 4 page 136.

**References**

Learner's book 4 (Physics for Rwanda Secondary Schools Book 4)  
Other available Physics books in the school library.

**Lesson 3: Types of equilibrium**

Period 3: (80 Minutes)

**Introduction**

Remember that learners studied this unit in O'level. Review their previous knowledge of equilibrium by use of leading questions.

Follow the flow of content from page 137 to 139 in learner's book, and guide the learners to define equilibrium of bodies.

Try to help learners to discover the types of Equilibrium

Help these learners to discuss these types i.e.

- stable equilibrium

- unstable equilibrium
- neutral equilibrium

### **Lesson Flow**

- Let the learners carry out activity 8 on page 137 in learner's book (if it is a mixed school, the number of boys and girls in each group should be balanced).
- Arrange learners in groups (select any number of learners depending on the size of the class) make sure that they work in harmony.
- Help them in selecting their group leaders.
- Recognise learners with special needs in group making. Encourage them to actively participate in their respective groups.
- Move around the class guiding learners as they are performing the activity. In case of any assistance you can make bright learners to assist the weak ones.
- Let the learners discuss their findings in their groups and finally present to the whole class.
- Consolidate the lesson by developing and giving your ideas basing on learners' ideas.

As the lesson progresses, look at the following key points as they will help learners to understand the concept;

### **Types of equilibrium**

There are three types of Equilibrium namely;

- Stable
- Unstable and
- Neutral Equilibrium

## **Lesson 4: Conditions for a body to be stable**

---

Period 4: (40 Minutes)

1. The object's base is broad.
2. The Centre of gravity is as low as possible.

3. The vertical line drawn from the Centre of gravity should fall within the base. Lowering the Centre of gravity of an object is important for stability.

**Together with learners perform the Activity below**

### Activity

Help the learners to perform the activity below

#### Requirements

- A log of wood
- A bottle
- A table
- A knife edge made of wood or A triangular glass prism
- A rectangular wooden block

#### Learner's activity

*Aim: To find out the effect of application of force onto the equilibrium on the stability of a body*

- Displace the desk. What happens when you withdraw the force you applied?
- Place a bottle on a table so that it rests on its horizontal surface. Displace or roll it. What happens?
- Place a knife edge on a table resting on its tip. Give it a small displacement. What happens to it?
- From the observations made, how do you conclude?

Guide the learners in performing the experiment and lead them to develop viable conclusions.

#### Possible deductions

- The desk returns to its original position
- The bottle rolls when displaced
- The knife edge falls in new position

#### Assessment criteria

Learners may be assessed using the following methods;

- by asking them oral questions.
- making learners to work out the activity on page 139.
- check and mark work of each learner.

## Lesson 5: Stevinus proof

---

Period 5: (40 Minutes)

Remember that its the first time for learners to study this concept.

So care must be taken so that learners know and apply the proof.

Using the introduction on pages 144 and 145 in learner's book, help learners to develop the proof and its applications.

Ask your learners to list down applications of the law of equilibrium.

### Lesson Flow

- Let the learners carry out activity **10 on page 145** in learner's book (if it is a mixed school, mix boys and girls).
- Arrange learners in groups (select any number of learners depending on the size of the class) make sure that they work in harmony.
- Help them in selecting their group leaders.
- Recognise learners with special needs in group making. Encourage them to actively participate in their respective groups.
- Move around the class guiding learners as they are performing the activity. In case of any assistance you can make bright learners to assist the weak ones.
- Let the learners discuss their findings in their groups and finally present to the whole class.
- Consolidate the lesson by developing and giving your ideas basing on learners' ideas.

### This is an Extract of Learner's Book, page 144

Stevin's proof of the law of equilibrium on an inclined plane, known as the "Epitaph of Stevinus".



He derived the condition for the balance of forces on inclined planes using a diagram with a “wreath” containing evenly spaced round masses resting on the planes of a triangular prism (see the illustration on the figure).

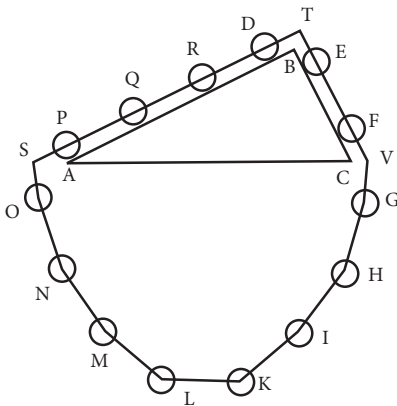

He concluded that the weights required were proportional to the lengths of the sides on which they rested assuming the third side was horizontal and that the effect of a weight was reduced in a similar manner.

### Stevenus proof diagram

#### Assessment criteria

Learners may be assessed using the following methods;

- by asking them oral questions.
- making learners to work out the activities on pages 145 and 146.
- check and mark work of each learner.

The methods mentioned above can be varied. The use of a particular method depends on the size of the class, level of learners, availability of scholastic materials, time of the day and the moods of the learners.

## Lesson 6: Forces in equilibrium

Period 6: (80 Minutes)

Remember that learners studied this unit in O’level. Review learners previous knowledge by use of guided questions and thought provoking questions.

Using the introductory work on page 143 in learner’s book, try to explain the effects of forces that are in equilibrium citing examples.

Let the learners give you other examples depending how they are understanding the concept.

### **Lesson Flow**

- Let the learners carry out work in learner's book (if it is a mixed school, the number of boys and girls in each should be balanced).
- Put learners in groups (select any number of learners depending on the size of the class) make sure that they work in harmony.
- Help them in selecting their group leaders.
- Recognise learners with special needs in group making. Encourage them to actively participate in their respective groups.
- Move around the class guiding learners as they are performing the work. In case of any assistance you can make bright learners to assist the weak ones.
- Let the learners discuss their findings in their groups and finally present to the whole class.
- Consolidate the lesson by developing and giving your ideas basing on learners' ideas.

### **Note**

Help the learners to work neatly and systematically and they should always put units.

### **Assessment criteria**

Learners may be assessed using the following methods;

- by asking them oral questions.
- making learners to work out the activities on page 126 (Activity 2 and Quick check page 126).
- check and mark work of each learner.

The methods mentioned above can be varied. The use of a particular method depends on the size of the class, level of learners, availability of scholastic materials, time of the day and the moods of the learners.

### **Additional content**

The following points will help learners to solve problems that involve a body acted on by three co-planar forces.

- (a) The line of action of forces must all pass through the same point.

- (b) The principle of moments: **The sum of all clock-wise moments about any point must have the same magnitude as the sum of all anti-clock wise moments about the same point.**

For the exercises and Notes check in learner's book Page 148.

### **References**

Learner's book 4 (Physics for Rwanda Secondary Schools Book 4)

Other available Physics books in the school library.

## **Lesson 7: Free body diagrams, couples & coplanar forces**

Period 7: (40 Minutes)

Remember that learners studied this unit in O'level. Review the learners' knowledge by use of challenging and leading questions.

Using the introductory work on page 147 in learner's book, together with your learners draw a free body diagram.

Set the learners to practise drawing free body diagrams.

### **Lesson Flow**

- Let the learners carry out work in learner's book (if it is a mixed school, the number of boys and girls in each group should be balanced).
- Put learners in groups (select any number of learners depending on the size of the class) make sure that they work in harmony.
- Help them in selecting their group leaders.
- Recognise learners with special needs in group making. Encourage them to actively participate in their respective groups.
- Move around the class guiding learners as they are performing the work. In case of any assistance you can make bright learners to assist the weak ones.
- Let the learners discuss their findings in their groups and finally present to the whole class.

Consolidate the lesson by developing and giving your ideas basing on learners' ideas.

### Assessment criteria

Learners may be assessed using the following methods;

- by asking them oral questions.
- making learners to work out the activities on page 129 - 139.
- check and mark work of each learner.

The methods mentioned above can be varied. The use of a particular method depends on the size of the class, level of learners, availability of scholastic materials, time of the day and the moods of the learners.

### Additional content

A door knob is located as far as possible from the hinge line for a good reason.

If you want to open a heavy door you must certainly apply a force, that done, where you apply that force and in what direction you push are very important.

The figure 3.1 on page 130 shows a force  $\vec{F}$  acting on a body that is free to rotate about an axis. The force is applied at the point P whose position is defined by the vector  $\vec{d}$ . The direction of  $\vec{F}$  and  $\vec{d}$  make an angle  $\alpha$  with each other.

We define the **torque**  $t$  acting on the body from:  
 $t = F \times d \times \sin \alpha$  (Extracted from Learner's Book, page 129)

The perpendicular distance of the line of action of the force from the axis of rotation is called the **moment arm** of the force.

The S. I unit of torque is Newton-metre [Nm] or metre-newton [Mn]

## Lesson 8: Couple of force

---

Period 8: (80 Minutes)

- Use the idea of married couple to explain the concept of couple of forces.
- Guide learners to work out the activity 5.

In physics **a couple**  $C$  consists of two equal and opposite parallel forces whose lines of action do not coincide. It always tends to change rotation.

## Resultant of coplanar forces

Refer to the notes in the learner's book pages 131.

### Parallelogram of forces

A force is a vector quantity. So it can be represented in size and direction by a straight line drawn to scale. The sum or resultant  $\vec{R}$  of two forces  $\vec{F}_1$  and  $\vec{F}_2$  can be added by one of two vector methods.

Check on pages 132 to 133.

### Resolved components

Therefore, when solving daily problems, it is often helpful to replace one force by a combination of two forces in particular directions. These directions are usually perpendicular to each other.

Their vector sum must be equivalent to the given force. If this condition is fulfilled, we say that **the force** has been **resolved into components**.

A simple geometrical construction provides the magnitudes of the components: We can draw two lines from the end of the given force vector parallel to the given directions. In this way, we get the so-called **parallelogram of forces**. The magnitudes of the components now can be read off from the sides of this parallelogram.

For the exercises and notes check in learner's book Page 132-133.

### References

Learner's book 4 (Physics for Rwanda Secondary Schools Book 4).

## Lesson 9: Equilibrium of coplanar forces

Period 9: (80 Minutes)

Remember that learners studied this unit in O'level.

Using leading questions, review the learners knowledge of coplanar forces.

Using the introductory work on page 134-145 in learner's book, together with the learners draw a free body diagram (Refer to page 135 in learner's book).

Set the learners to practise drawing free body diagrams and use them in problem solving.

### Lesson Flow

- Let the learners carry out work in learner's book (if it is a mixed school, the number of boys and girls in each group should be balanced).
- Put learners in groups (select any number of learners depending on the size of the class) make sure that they work in harmony.
- Help them in selecting their group leaders.
- Recognise learners with special needs in group making. Encourage them also participate in their respective groups.
- Move around the class guiding learners as they are performing the work. In case of any assistance you can make bright learners to assist the weak ones.
- Let the learners discuss their findings in their groups and finally present to the whole class.
- Consolidate the lesson by developing and giving your ideas basing on learners' ideas.

### Assessment criteria

Learners may be assessed using the following methods;

- by asking them oral questions.
- making learners to work out the activities on pages 134 - 139.
- check and mark work of each learner.

The methods mentioned above can be varied. The use of a particular method depends on the size of the class, level of learners, availability of scholastic materials, time of the day and the moods of the learners.

### Additional content

If a body is at rest, then, the net force is zero.

Therefore, if the resultant forces acting on a body is zero, the body is stationary and said to be in equilibrium.

The following pointers will help learners to solve problems that involve a body being acted on by three co-planar forces.

The line of action of the three forces must ***all pass through the same point.***

The principle of moments: The sum of all clock-wise moments about **any point** must have the same magnitude as the sum of all anti-clock wise moments about the same point

Set the learners to work through exercises in learner's book pages 149, 151-154.

### **References**

Learner's book 4 (Physics for Rwanda Secondary Schools Book 4)

## **Lesson 10: Archimedes and the principles of the lever**

Period 10: ( 80 Minutes)

Remember that learners studied this unit in O'level. Review the learners knowledge of levers and archimedes principle on levers using leading questions.

Using the introductory work on page 145 in learner's book, set the learners to continue practising the drawing of free body diagrams (Refer to page 145 in learner's book).

### **Lesson Flow**

- Let the learners carry out work in learner's book (if it is a mixed school, the number of boys and girls in each group should be balanced).
- Put learners in groups (select any number of learners depending on the size of the class) make sure that they work in harmony.
- Help them in selecting their group leaders.
- Recognise learners with special needs in group making. Encourage them to actively participate in their respective groups.
- Move around the class guiding learners as they are performing the work. In case of any assistance you can make bright learners to assist the weak ones.
- Let the learners discuss their findings in their groups and finally present to the whole class.
- Consolidate the lesson by developing and giving your ideas basing on learners' ideas.

### Assessment criteria

Learners may be assessed using the following methods;

- by asking them oral questions.
- making learners to work out the activities on page 146.
- check and mark work of each learner.

The methods mentioned above can be varied. The use of a particular method depends on the size of the class, level of learners, availability of scholastic materials, time of the day and the moods of the learners.

### Additional content

Building up from the earliest remaining writings regarding levers date from the 3rd century BC and were provided by Archimedes. *“Give me a place to stand, and I shall move the Earth with it”* is a remark of Archimedes who formally stated the correct mathematical principle of lever

For the exercises and Notes and Homework check in learner's book Page 145-149.

### References

Learner's book 4 (Physics for Rwanda Secondary Schools Book 4)

## Lesson 11: Equilibrium of moments of force and centre of gravity

Period 11: (120 Minutes)

Remember that learners studied this unit in O'level. Review the learners' knowledge of moments of a force and centre of gravity using guided questions.

Using the introductory work on page 137 in learner's book, together with the learners, draw a free body diagram.

Set your learners to practise drawing free body diagrams so as to understand the concept.



### Lesson Flow

- Let the learners carry out work in learner's book (if it is a mixed school, the number of boys and girls in each group should be balanced).
- Put learners in groups (select any number of learners depending on the size of the class) make sure that they work in harmony.
- Help them in selecting their group leaders.
- Recognise learners with special needs in group making. Encourage them to actively participate in their respective groups.
- Move around the class guiding learners as they are performing the work. In case of any assistance you can make bright learners to assist the weak ones.
- Let the learners discuss their findings in their groups and finally present to the whole class.
- Consolidate the lesson by developing and giving your ideas basing on learners' ideas.

### Assessment criteria

Learners may be assessed using the following methods;

- by asking them oral questions.
- making learners to work out the activities on page 146.
- check and mark work of each learner.

The methods mentioned above can be varied. The use of a particular method depends on the size of the class, level of learners, availability of scholastic materials, time of the day and the moods of the learners.

### Additional content

**A lever is a movable bar that pivots on a fulcrum attached to a fixed point.** The lever operates by applying forces at different distances from the fulcrum, or a pivot.

### Example from learner's book, page 147

2. A seesaw consisting of a uniform board of mass  $M = 10\text{kg}$  and length  $l = 2\text{m}$  supports a father and daughter with masses  $m_f$  and  $m_d$ ,  $50\text{kg}$  and  $20\text{kg}$  respectively as shown in Figure. The support (called the fulcrum) is under the center of gravity of the board, the father is a distance  $d$  from the center, and the daughter is a distance  $l/2$  from the center. (a) Determine the magnitude of the upward

force  $n$  exerted by the support on the board. (b) Determine where the father should sit to balance the system.

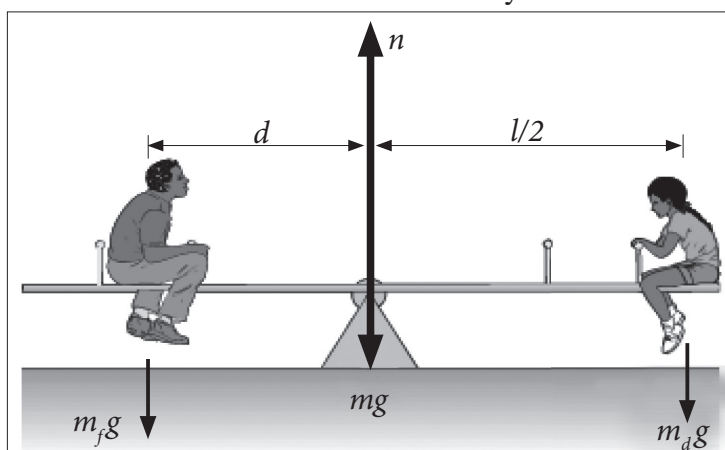

### Solution

Up ward forces = Downward forces

Hence,  $n = m_f g + m_d g + mg$

a) Thus,  $n = m_f g + m_d g + mg$

and,  $m_f = 50\text{kg}$ ,  $m_d = 20\text{kg}$ ,  $g = 10\text{ms}^{-2}$ ,  $m = 10\text{kg}$

$$n = (50 \times 10 + 20 \times 10 + 10 \times 10)$$

$$n = (500 + 200 + 100)$$

$$n = 800\text{N}$$

b) Sum of clockwise moments = Sum of anti clockwise moments

$$m_f \times d = m_d \times \frac{l}{2}$$

$$50 \times d = 20 \times \frac{2}{2}$$

$$50d = 20\text{m}$$

$$d = \frac{20\text{m}}{50}$$

$$d = 0.4\text{m}$$

Other examples and exercises on pages 144-147.

For the exercises and Notes and Homework check in learner's book Page 148-151.

Set the learners to work through exercise on pages 148-151.

### References

Learner's book 4 (Physics for Rwanda Secondary Schools Book 4).

# UNIT 4

## Work, Energy and Power

**Learner's book pages 157-193**

**Key unit competence:** By the end of this unit the learners should be able to evaluate relationship between work energy and power.



### Learning objectives

Learners should be able to:

- explain the concept of mass and energy
- evaluate quantitatively work, energy and power
- derive formulas of work energy and power
- describe and explain the conservation of energy in the universe

**Others in the curriculum page 29**

This unit is to be taught in 19 lessons, each of 40minutes

Evaluation must be carried out within the allocated time.

### Unit Breakdown

Serial number	Lesson title	Number of minutes	Periods
1	Concept of work energy and power	80	2
2	Mathematical expression of PE, KE, work and power	80	2
3	Conservation of Mechanical Energy& Work energy theorem	120	3
4	Strain Energy, Gravitational Potential Energy, power and Motion	120	3
5	Work done in Deforming a material, Collision and Impulse	120	3
6	Conservation of linear momentum, Interractions and collision	160	4
7	Problems Related to Energy conservation	80	2

## Lesson 1: Concept of work, energy and power

Period 1: (80 Minutes)

### Introduction

Remember that learners studied this unit in O'level. Review the learners' knowledge of the concepts of work, power and energy by use of leading and thought provoking questions.

Make sure that learners' contributions are respected. Extract key points and should be noted in their books.

Using the introduction on page 157 in learner's book, guide the learners to describe the terms work, energy and power.

**Work is done when a force moves its point of application along the direction of its action.**

From the formula, Work is **the product of the component of the force in the direction of the motion and displacement in that direction.**

That is:  $W = F \times d \times \cos\theta$

Request the learners to list down examples of work, energy.

### Lesson Flow

- Let the learners carry out activity 4 on page 161 in learner's book.
- Put learners in groups (select any number of learners depending on the size of the class) make sure that they work in harmony.
- Help them in selecting their group leaders.
- Recognise learners with special needs in group making. Encourage them to actively participate in their respective groups.
- Move around the class guiding learners as they are performing the activity. In case of any assistance you can make bright learners to assist the weak ones.
- Let the learners discuss their findings in their groups and finally present to the whole class.

- Consolidate the lesson by developing and giving your ideas basing on learners' ideas.

### Assessment criteria

Learners may be assessed using the following methods;

- by asking them oral questions.
- making learners to work out the activities on page 158-160.
- check and mark work of each learner.

The methods mentioned above can be varied. The use of a particular method depends on the size of the class, level of learners, availability of scholastic materials, time of the day and the moods of the learners.

### Additional content/points you should never forget

The S.I unit of work is Joule (J)

**A *Joule* is the work done by a force of 1N when its application point moves through a distance of 1 metre in the direction of force.**

Work is the scalar although force and displacement are both vectors.

### References

Learner's book 4 (Physics for Rwanda Secondary Schools Book 4)  
Other available Physics books in the school library.

## Lesson 2: Mathematical expression of potential energy kinetic energy and power

Period 2: (80 Minutes)

Remember that learners studied this concept in O'level and even in previous lesson. Using thought provoking questions, review the learners' knowledge of potential and kinetic energy.

Together with the learners derive the equation for Kinetic Energy  $k. e = \frac{1}{2} mV^2$  where  $m$  is the mass and  $V$  is Velocity of the body.

Potential Energy  $p.e = mgh$

Ask your learners to show that power is the rate of doing work.

Guide the learners to discover that  $\text{Power} = \frac{\text{Work done}}{\text{time}}$

Using guided questions lead the learners to discover the importance of studying these concepts in physics.

Request the learners to list down different examples of potential energy.

### **Lesson Flow**

- Let the learners carry out activity 5 on page 162 in learner's book (if it is a mixed school, the number of boys and girls in each group should be balanced).
- Put learners in groups (select any number of learners depending on the size of the class) make sure that they work in harmony.
- Help them in selecting their group leaders.
- Recognise learners with special needs in group making. Encourage them to actively participate in their respective groups.
- Move around the class guiding learners as they are performing the activity. In case of any assistance you can make bright learners to assist the weak ones.
- Let the learners discuss their findings in their groups and finally present to the whole class.
- Consolidate the lesson by developing and giving your ideas basing on learners' ideas.

Guide the learners to work through the exercises on page 168 in the learner's book.

### **Note**

While doing this exercise try to move around in case of any assistance to the learners. Help them mark and make corrections for the work.

### **Assessment criteria**

Learners may be assessed using the following methods;

- by asking them oral questions.
- making learners to work out the activities on pages 164-166.
- check and mark work of each learner.
- giving exercises and tests.

The methods mentioned above can be varied. The use of a particular method depends on the size of the class, level of learners, availability of scholastic materials, time of the day and the moods of the learners.

For notes and more questions use learner's book page 167-168.

### References

Learner's book 4 (Physics for Rwanda Secondary Schools Book 4)

Other available Physics books in the school library.

## Lesson 3: Conservation of mechanical energy and work energy theorem

Period 3: (120 Minutes)

### Introduction

Using challenging and thought provoking questions, review the previous lesson. Build on this to introduce the concept of work energy theorem and conservation of mechanical energy.

Theorem: ***“The net work done on an object is equal to its change in kinetic energy”***

This is known as the ***work-energy theorem***.

The ***principle of conservation of mechanical energy*** can be stated as follows: ***“The total amount of mechanical energy of an isolated body is a constant***

Set the learners to read the content on page 168-169 in learner's book. Using thought provoking questions guide the learners to interpret the information read.

### Lesson Flow

- Let the learners carry out activity 8 on page 170 in learner's book (if it is a mixed school, the number of boys and girls in each group should be balanced).
- Put learners in groups (select any number of learners depending on the size of the class) make sure that they work in harmony.
- Help them in selecting their group leaders.

- Recognise learners with special needs in group making. Encourage them to actively participate in their respective groups.
- Move around the class guiding learners as they are performing the activity. In case of any assistance you can make bright learners to assist the weak ones.
- Let the learners discuss their findings in their groups and finally present to the whole class.
- Consolidate the lesson by developing and giving your ideas basing on learners' ideas.

#### **Assessment criteria**

Learners may be assessed using the following methods;

- by asking them oral questions.
- making learners to work out the activities on page 174.
- check and mark work of each learner.

**Note:** For other graphs and Equations, check in the learner's book 4 and other books available in our library.

### **Lesson 4: Strain energy, gravitational p. e, power and motion**

Period 4: (120 Minutes)

Using guided and thought provoking questions lead the learners to define strain energy, gravitational potential energy and power.

Lead your learners to discover why they are studying this concept in physics.

#### **Lesson Flow**

- Let the learners carry out activity 11 on page 176 in learner's book (if it is a mixed school, the number of boys and girls in each group should be balanced).
- Put learners in groups (select any number of learners depending on the size of the class) make sure that they work in harmony.
- Help them in selecting their group leaders.
- Recognise learners with special needs in group making. Encourage them to actively participate in their respective groups.



- Move around the class guiding learners as they are performing the activity. In case of any assistance you can make bright learners to assist the weak ones.
- Let the learners discuss their findings in their groups and finally present to the whole class.
- Consolidate the lesson by developing and giving your ideas basing on learners' ideas.

**Assessment criteria**

Learners may be assessed using the following methods;

- by asking them oral questions.
- making learners to work out the exercise on page 175.
- check and mark work of each learner.

The methods mentioned above can be varied. The use of a particular method depends on the size of the class, level of learners, availability of scholastic materials, time of the day and the moods of the learners.

**Note** for other information and Equations check in the books that are available in your library.

**Lesson 5: Work done in deforming materials, collision and impulse**

Period 5: (120 Minutes)

Review the previous lesson with the help of challenging and leading questions.

Considering the figure extracted from learner's book page 166.

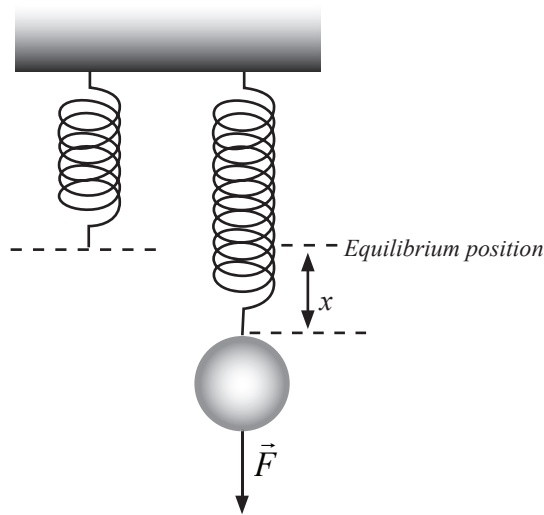

On a spring on which a force  $\vec{F}$  is exerted producing an extension of length  $x$ . According to the Hooke's law:

$F = kx$  where  $k > 0$  is the constant depending on the string

The potential energy stored is  $p.e = \frac{1}{2}kx^2$

For more information see page 164 in learner's book 4

### About impulse

The impulse is equal to the total change of momentum.

For more information see page 176-178 in the learner's book 4.

### Collision

We define collision as an interaction between bodies in which the time intervals during which the bodies interaction is small relative to the time for which we can observe them

#### There are two types of collisions

- Elastic collision
- Inelastic collision

Explanations and formulas are in learner's book.

Make learners to work out different activities under your guidance.

Let the learners participate in deriving these equations.

### **Guidance while teaching**

- Let the learners carry out work in learner's book (if it is a mixed school, the number of boys and girls in each group should be balanced).
- Put learners in groups (select any number of learners depending on the size of the class) make sure that they work in harmony.
- Help them in selecting their group leaders.
- Recognise learners with special needs in group making. Encourage them to actively participate in their respective groups.
- Move around the class guiding learners as they are performing the work. In case of any assistance you can make bright learners to assist the weak ones.
- Let the learners discuss their findings in their groups and finally present to the whole class.
- Consolidate the lesson by developing and giving your ideas basing on learners' ideas.

### **Note**

Help the learners to work neatly and systematically and they should always put units (SI Units).

### **Extra content**

Check in learner's book page 180 to 185.

### **Assessment criteria**

Learners may be assessed using the following methods;

- by asking them oral questions.
- making learners to work out the activities on page 180 to 185.
- check and mark work of each learner.

The methods mentioned above can be varied. The use of a particular method depends on the size of the class, level of learners, availability of scholastic materials, time of the day and the moods of the learners.

## Lesson 6: Conservation of linear momentum

Period 6: (160 Minutes)

Using leading questions review the concepts of momentum and linear momentum.

Momentum is “**The product of body’s mass and its velocity**”

Use challenging and thought provoking questions to guide the learners to define the principal of conservation of linear momentum

This is:

**When two or more bodies collide the total momentum is constant.**

**For more information about collisions, check in learner’s book from page 174 to 185.**

### Lesson Flow

- Let the learners carry out work in learner’s book (if it is a mixed school, the number of boys and girls in each group should be balanced).
- Put learners in groups (select any number of learners depending on the size of the class) make sure that they work in harmony.
- Help them in selecting their group leaders.
- Recognise learners with special needs in group making. Encourage them to actively participate in their respective groups.
- Move around the class guiding learners as they are performing the work. In case of any assistance you can make bright learners to assist the weak ones.
- Let the learners discuss their findings in their groups and finally present to the whole class.
- Consolidate the lesson by developing and giving your ideas basing on learners’ ideas.

For more information (Notes and exercises check in learner’s book pages 174 to 185.

### Assessment criteria

Learners may be assessed using the following methods;

- by asking them oral questions.

- making learners to work out the activities on page 176.
- check and mark work of each learner.

The methods mentioned above can be varied. The use of a particular method depends on the size of the class, level of learners, availability of scholastic materials, time of the day and the moods of the learners.

### **References**

Learner's book 4 (Physics for Rwanda Secondary Schools Book 4)

## **Lesson 7: Problems related to energy conservation**

Period 7: (80 Minutes)

Review the previous lessons using challenging questions.

Make sure learner's suggestions are clarified and written in their books.

### **Lesson Flow**

- Let the learners carry out work in learner's book (if it is a mixed school, the number of boys and girls in each group should be balanced).
- Put learners in groups (select any number of learners depending on the size of the class) make sure that they work in harmony.
- Help them in selecting their group leaders.
- Recognise learners with special needs in group making. Encourage them to actively participate in their respective groups.
- Move around the class guiding learners as they are performing the work. In case of any assistance you can make bright learners to assist the weak ones.
- Let the learners discuss their findings in their groups and finally present to the whole class.
- Consolidate the lesson by developing and giving your ideas basing on learners' ideas.

### **Assessment criteria**

Learners may be assessed using the following methods;

- by asking them oral questions.
- check and mark work of each learner.

The methods mentioned above can be varied. The use of a particular method depends on the size of the class, level of learners, availability of scholastic materials, time of the day and the moods of the learners.

You can use books in the library for more research or obtain information from the Internet.

### **References**

Learner's book 4 (Physics for Rwanda Secondary Schools Book 4)

## UNIT 5

# Kirchhoff's Laws and Electric Circuits

**Learner's book pages 197-237**

**Key unit competence:** By the end of the unit the learner should be able to analyse complex electric circuits using Kirchhoff's laws.



### Learning objectives

---

Learners should be able to:

- correctlly connect electric components in a circuit when measuring current.
- connect electric components in series and in parallel.
- differentiate between a series and a parallel connection.
- determine characteristics of a series and parallel connection.
- describe the advantages of connection in series and connection in parallel.
- differentiate between the different types of sources of electric current.
- understand that to find an electric energy, there is another type of energy which must be changed in electric energy.
- describe the important characteristics of a generator called emf and an internal resistance
- develop positive values and attitudes such as curiosity, honesty, and respect for evidence, perseverance and tolerance of uncertainty through the study of electric circuit.
- calculate the energy and the power supplied by generators.
- calculate the power dissipated in the generator by Joule's effect.
- explain how a generator is represented in an electric circuit.
- determine experimentally the emf and internal resistance of a generator.

- explain the difference between potential difference and electromotive force.
- calculate the efficiency of a cell.
- write the Ohm's law for a circuit having a cell and a resistor.
- connect cells and resistors in series and parallel and to determine the effective emf and resistance.
- calculate the total emf and equivalent total internal resistance of a combination in series and in opposition of cells (generators).
- identify some receptors.
- differentiate a receptor and a passive resistor.
- list the main characteristics of a receptor.
- determine the relation between the pd and the back emf at terminals of a receptor.
- explain the condition of functioning when a circuit has a generator, and a receptor.
- connect resistors and cells, and to measure the current through the circuit.
- determine the equivalent resistance in a circuit, resolve simple circuits using Kirchhoff's laws.
- apply Kirchhoff's rules in simple circuits.
- calculate the intensity of the current in simple circuit using Kirchhoff's rules.
- Solve problems related to Kirchhoff's rules.

This unit is to be taught in 20 periods, each of 40 minutes.

Evaluation must be done in allocated time.



### Unit Breakdown

Serial number	Lesson title	Number of minutes	Periods
1	Review of elements of simple electric circuits and their respective role: Making a simple electric circuit,	40	1
2	Making a series and parallel circuits	80	2
3	Generators and receptors: Generators, sources of electric current	40	1
4	Electromotive force of a generator, Internal resistance of the generator	80	2
5	Relationship between the p. d and the emf at terminals of a cell of closed circuit	40	1
6	Efficiency of a cell, Ohm's law for a circuit having a cell and a resistor.	40	1
7	Combination of cells, Combination of cells (Interpretation of experimental results) Combination in series and opposition, Combination in parallel and mixing a series and a parallel combination	80	2
8	Receptors: Back electromotive force Internal resistance, The pd at terminals of a receptor	40	1
9	Generators and receptors: Exercises	160	4
10	Kirchhoff's rules	80	2
11	Kirchhoff's rules: Exercises	120	3
	Total	800	20

#### Lesson 1: Review of elements of simple electric circuits and their respective role

Period 1: (40 Minutes)

- Making a simple electric circuit

Step 1: Divide the learners in groups of 3 or 4 learners each depending on the number of learners in class.

Step 2: Show learners different materials relevant to the lesson and recommend learners to follow the procedure and answer different questions as suggested in the learner's book.

Step 3: Instruct learners to carry out Activity 1 in the Learner's book on page 199.

- Step 4: Explain to learners that in this unit, they will learn about electric circuits, the reason why there is flow of electric current and what makes an electric circuit. Also the Teacher should let learners explain and discover that the way of producing light in the bulb is one of the effects of electric current.
- Step 5: In order to introduce the next lesson, show that an electric circuit is composed of several electric components which can be combined in different ways.

### **Lesson Flow**

- Let the learners carry out the related activity in learner's book (if it is a mixed school, the number of boys and girls in each group should be balanced).
- Put learners in groups (select any number of learners depending on the size of the class) make sure that they work in harmony.
- Help them in selecting their group leaders.
- Recognise learners with special needs in group making. Encourage them to actively participate in their respective groups.
- Move around the class guiding learners as they are performing the activity. In case of any assistance you can make bright learners to assist the weak ones.
- Let the learners discuss their findings in their groups and finally present to the whole class.
- Consolidate the lesson by developing and giving your ideas basing on learners' ideas.

### **Note**

Help the learners to work neatly and systematically.

### **Assessment criteria**

Learners may be assessed using the following methods;

- by asking them oral questions.
- making learners to work out activities.
- check and mark work of each learner.

The methods mentioned above can be varied. The use of a particular method depends on the size of the class, level of learners, availability of scholastic materials, time of the day and the moods of the learners.

## References

Learner's book 4 (Physics for Rwanda Secondary Schools Book 4)

Other available Physics books in the school Library.

## Lesson 2: Making a series and parallel circuits

Period 2: (80 Minutes)

- Step 1: Let the Learners do Activity 2 and activity 3 pages 201 and 203 in the learner's book.
- Step 2: Let them follow step by step the procedure in the learner's book. As suggested, they should be answering questions on the spaces provided in the book.
- Step 3: After submission of the work, give a summary giving the characteristics of a series and parallel circuits. Together with the learners identify the advantages and disadvantages of these connections.

### Characteristics of series and parallel circuits

- In series, the voltage at terminals of the battery is the sum of voltages in different parts while the intensity of the current is the same at each point of the circuit.
- In parallel, the voltage at terminals of the battery is the same as at terminals of different branches while the intensity of the current is the sum of intensities in different branches.

### Advantages and disadvantages of series and parallel circuits

A **series circuit** is basically a circuit that contains just one single path for the power source to go through. What this means is that the circuit current has to flow throughout the entire load. More often than not, this type of circuit is used with Christmas lights. The main disadvantages are:

- If one component in a series circuit fails, then all the components in the circuit fail because the circuit has been broken.
- The more components there are in a series circuit, the greater the circuit's resistance to the flow of the current.
- There are several advantages to keep in mind as well. Many people will automatically reject a series circuit because of the

above disadvantages. Unfortunately, they will be missing out on several advantages in the process.

- **Adding Power devices:** The biggest advantage of a series circuit is that you can add additional power devices, usually using batteries. Doing this will greatly increase the overall strength of your output. This will help to give you more power. Your bulbs may not shine as brightly once you have done this, but you probably won't notice the difference. This advantage by and large outweighs the single disadvantage.
- **Ease of Use:** Series circuits are easy to learn and to make. Its simple design is easy to understand. This will help you make repairs without the help of a professional. This will also help you calculate the voltage of your circuit.

**Parallel circuits** provide more than one path for current. After current leaves a source, it follows two or more paths before returning to the source. When several bulbs or components are connected in parallel, fault in any one, or removal of any one does not affect flow of current to others.

### **Advantages**

- It is used in houses, so if one light goes out others do not get affected by it.
- Every unit that is connected in a parallel circuit gets equal amount of voltage.
- Parallel circuits are used in cases of multiple loads.
- It becomes easy to connect or disconnect a new element without affecting the working of other elements. For example: the elements that are connected via wall outlets can be switched on or off without hampering the working of the other one running/ or at rest, at the same time.

### **Disadvantages**

- It requires the use of lot of wires.
- The source amperage is increased whenever we add a new load to a parallel circuit.
- Due to proper working, sometimes the damage if any, caused to the circuit, may get neglected. This is hazardous.
- We cannot increase or multiply the voltage in a parallel circuit.

- Multiple control devices are employed for the control of the devices in parallel connection.
- Parallel connection fails at the time when it is required to pass exactly same amount of current through the units.
- The design of a parallel circuit is very complex.
- Additional power sources like batteries cannot be added in parallel connection.
- The teacher will lead the students to discover that in houses installations are in parallel connection due to their advantages. He'll show that from WASAC (company of distribution of electric energy in Rwanda) connections are also in parallel.

Step 4: After this lesson, the teacher will plan the teaching of the next lesson on the sources of electric current. He will give the subject to learners and tell them to go to do research on internet and books so that for the next lesson learners will have ideas of what they have to study. They can search for solutions to the following questions:

- What is a source of electric current?
- What is another name of electric sources of energy?
- List some of the sources of electric energy you have found.
- What type of energy is changed in electric energy?

#### **Lesson Flow**

- Set the learners carry out the related activity in learner's book (if it is a mixed school, the number of boys and girls in each group should be balanced).
- Put learners in groups (select any number of learners depending on the size of the class) make sure that they work in harmony.
- Help them in selecting their group leaders.
- Recognise learners with special needs in group making. Encourage them to actively participate in their respective groups.
- Move around the class guiding learners as they are performing the activity. In case of any assistance you can make bright learners to assist the weak ones.
- Let the learners discuss their findings in their groups and finally present to the whole class.
- Consolidate the lesson by developing and giving your ideas basing on learners' ideas.

**Note**

Help the learners to work neatly and systematically.

**Assessment criteria**

Learners may be assessed using the following methods;

- by asking them oral questions.,
- making learners to work out activities,
- check and mark work of each learner.

The methods mentioned above can be varied. The use of a particular method depends on the size of the class, level of learners, availability of scholastic materials, time of the day and the moods of the learners.

**References**

Learner's book 4 (Physics for Rwanda Secondary Schools Book 4)  
Other available Physics books in the school Library.

---

**Lesson 3: Generators and receptors**

---

Period 3: (40 Minutes)

**Generators; sources of electric current**

- Step 1: Remind the learners that they had already been given homework in the previous lesson which consists of search on internet about sources of electric energy. Ask them to present their findings and guide them to develop conclusions.
- Step 2: Let the learners carry out activity 4 page 205 in an appropriate place (computer lab or another place) in order to complete the work they did and to encourage the team work.
- Step 3: Instruct the learners to carry out research individually and present their findings.
- Step 4: Set the learners discuss in class in order to find the correct ones. After they discuss as a class, the answers found in others to give the final ones.
- Step 5: Together with your learners, develop and build a summary of the activity.

### **Conclusion**

A source of electric energy is any device, any apparatus which can convert any kind of energy in electric energy. They are also called **generators**.

For example a battery, a cell converts chemical energy in electric energy. Dynamos, alternators, etc. convert mechanical energy in electric energy. Solar panel converts solar energy in electric energy, etc.

### **Lesson Flow**

- Set the learners carry out the related activity in learner's book (if it is a mixed school, the number of boys and girls in each group should be balanced).
- Put learners in groups (select any number of learners depending on the size of the class) make sure that they work in harmony.
- Help them in selecting their group leaders.
- Identify learners with special needs in group making. Encourage them to actively participate in their respective groups.
- Move around the class guiding learners as they are performing the activity. In case of any assistance you can make bright learners to assist the weak ones.
- Let the learners discuss their findings in their groups and finally present to the whole class.
- Consolidate the lesson by developing and giving your ideas basing on learners' ideas.

### **Note**

Help the learners to work neatly and systematically.

### **Assessment criteria**

Learners may be assessed using the following methods;

- by asking them oral questions.
- making learners to work out activities.
- check and mark work of each learner.

The methods mentioned above can be varied. The use of a particular method depends on the size of the class, level of learners, availability of scholastic materials, time of the day and the moods of the learners.

### **References**

- Learner's book 4 (Physics for Rwanda Secondary Schools Book 4)
- Other available Physics books in the school library.

## **Lesson 4: Generators: Electromotive force of a generator, Internal resistance of a generator**

Period 4: (40 Minutes)

- Step 1: Set the learners to carry out activity 5 page 207 step by step, collect data and answer questions therein.
- Step 2: When the learners complete their assignment, the teacher will summarise their findings and give the information in the learner's book.
- Step 3: With learners, establish and explain different related formulae which are in the learner's book related to the activity.
- Step 4: To wind up with the topic of electromotive force, work through given examples on the unit. Check if answers are correct. They are numerical applications of formula.
- Step 5: Learners carry out activity 6 page 210. Select the generators to use and the apparatus in which they will power. The purpose is to show that after a certain time of functioning the generator increase the temperature.
- Step 6: Set the learners to give answers to questions which are in the activity.  
Suggested answers:  

The temperatures of cells are not equal. You'll find that cells after being used are hotter than before. The reason is because; the current flowing in the circuit is also consumed by the cell. That hotness is due to the Joule's effect.
- Step 7: Conclude by saying that: "We conclude that a cell as other generators of electric current have a resistance called internal resistance".
- Step 8: The teacher develops more information from the learner's book.
- Step 9: Give some example with the purpose of retaining the formula. Check what the learners have done.



Step 10: Emphasise on the symbol of a generator and show that it must have the two characteristics (E, r).

Step 11: Explain that in charging a phone, there is an electric current flowing in the battery. This raises the temperature in a battery and proves the existence of an internal resistance. It's not advised to use the phone if it's in the charge because the increasing of the temperature of the phone in use plus the temperature when it's in charging process can make damage to the battery; even the working system of the phone.

**Note:** It's possible that, when preparing this lesson the teacher has no consecutive periods for that. He can teach them separately to mean the emf and internal resistance. As each one has its activity it's simple to be done but make sure that the two are finished in two periods and all information is given. But the best is to teach them in consecutive periods.

Step 12: Tell the learners that the activity which will be done is one among many which help to find experimentally the emf and internal resistance of a given generator (here the case of a cell).

Step 13: Set the learners to carry out activity 7 page 212. All steps must be followed by learners as in the learner's book and the teacher has to make sure that every thing is done systematically.

Step 14: Check the plot of the graph and clearly explain (scales, directions.)

**Note:** As suggested in the learner's book, the teacher can use Excel (from computer) to plot the graph. In the case of no access to it, the teacher should remind to learners the equation  $y = mx + b$  of a straight line, how it's sketched and that  $m$  is the gradient. How to find coordinates of intersection of a line and axis, etc. Here, the teacher should recall mathematical notions on a straight line.

### **Lesson Flow**

- Let the learners carry out the related activity in learner's book (if it is a mixed school, the number of boys and girls in each group should be balanced).
- Put learners in groups (select any number of learners depending on the size of the class) make sure that they work in harmony.
- Help them in selecting their group leaders.
- Identify learners with special needs in group making. Encourage them to actively participate in their respective groups.

- Move around the class guiding learners as they are performing the activity. In case of any assistance you can make bright learners to assist the weak ones.
- Let the learners discuss their findings in their groups and finally present to the whole class.
- Consolidate the lesson by developing and giving your ideas basing on learners' ideas.

### **Note**

Help the learners to work neatly and systematically.

### **Assessment criteria**

Learners may be assessed using the following methods;

- by asking them oral questions.
- making learners to work out activities.
- check and mark work of each learner.

The methods mentioned above can be varied. The use of a particular method depends on the size of the class, level of learners, availability of scholastic materials, time of the day and the moods of the learners.

### **References**

Learner's book 4 (Physics for Rwanda Secondary Schools Book 4)

Other available Physics books in the school library.

**Note:** It's possible that, when preparing this lesson the teacher has no consecutive periods for that. He can teach them separately to mean the emf and internal resistance. As each one has its activity it's simple to be done but make sure that the two are finished in two periods and all information is given. But the best is to teach them in consecutive periods.

## **Lesson 5: Relationship between the p.d and the emf at terminals of a cell of closed circuit**

Period 5: (40 Minutes)

Step 1: Let the learners carry out activity 8. Learners must carry out the experiment following procedures.

All steps must be followed up to the verification of the final relation.

- Step 2: Carry out the interpretation of the relation. Pay attention because the relation misses one element when verified experimentally. This is due to the resistance  $R$  of the ohmmeter which was connected in series with the internal resistance  $r$  of the cell but in the relation found in the interpretation, there is no ohmmeter then that quantity is zero.
- Step 3: Let the learners work through those examples, just where they apply the formula.

### **Lesson Flow**

- Let the learners carry out the related activity in learner's book (if it is a mixed school, mix boys and girls).
- Put learners in groups (select any number of learners depending on the size of the class) make sure that they work in harmony.
- Help them in selecting their leaders.
- Identify learners with special needs in group making. Encourage them to actively participate in their respective groups.
- Move around the class guiding learners as they are performing the activity. In case of any assistance you can make bright learners to assist the weak ones.
- Let the learners discuss their findings in their groups and finally present to the whole class.
- Consolidate the lesson by developing and giving your ideas basing on learners' ideas.

### **Note**

Help the learners to work neatly and systematically.

### **Assessment criteria**

Learners may be assessed using the following methods;

- by asking them oral questions.,
- making learners to work out activities,
- check and mark work of each learner.

The methods mentioned above can be varied. The use of a particular method depends on the size of the class, level of learners, availability of scholastic materials, time of the day and the moods of the learners.

### References

Learner's book 4 (Physics for Rwanda Secondary Schools Book 4)  
Other available Physics books in the school Library.

## Lesson 6: Efficiency of a cell, Ohm's law for a circuit having a cell and a resistor

Period 6: (40 Minutes)

- Step 1: Before writing the title on the black board, let learners carry out Activity 9 page 215 and from given answers (after question (e)) write the title "efficiency of a cell" on the black board.
- Step 2: **Suggested answers:** (a) see the meanings in the previous lesson. (b) No because in the relation we see that the total power supplied by the cell is the sum of the power dissipated by the internal resistance of the cell and the power supplied to the external circuit. (c) In general it's called the efficiency of the machine. (d) It has no unit and it's expressed in percentage [%]. (e) That special name is the efficiency of the cell; it has no unit also because it's a ratio of two quantities of same unit. (f) No. (g) Yes
- Step 3: After that, develop the relationships below and guide the learners discover that it is true for all generators.

The ratio  $\eta = \frac{P_e}{P}$  is the efficiency of a cell, where  $P_e$ : the power supplied by a cell to the external circuit and  $P$  is the total power supplied by the cell.

The efficiency is expressed as percentage [%].

$$\text{We can write: } \eta = \frac{P_e}{P} = \frac{P - P_i}{P} = 1 - \frac{P_i}{P}$$

$$\text{We can deduce other relations: } \eta = \frac{P_e}{P} = \frac{VI}{EI} \Rightarrow \eta = \frac{V}{E} \%$$

- Step 4: Guide the learners to discover that the efficiency has no unit. It's a ratio between two quantities of same unit then this one will be expressed in percentage.

Step 5: Build, together with the learners “Ohm’s law for an electric circuit having a cell and a resistor and let learners carry out activity 10 page 215.

Step 6: After the activity, let learners submit the work and guide them to develop a summary. Some suggested answers: (a) In an electric circuit the ratio between the voltage and the intensity of the current is constant and gives the resistance of the circuit  $V/I = R$ . It means  $V = R I$ . (b) In the circuit we have a resistor of resistance  $R$ , a cell of emf  $E$  and internal resistance  $r$  and connecting wires. (c) Yes, because electric current can flow through them. (d) They are in series because the same current flows through each out of them (e) The total resistance in series is given by the sum of constituting resistances.

We can write:  $P = EI, P_i = rI^2, P_e = RI^2$

$$P = P_i + P_e \Rightarrow EI = I^2r + I^2R = I^2(r + R)$$

$$E = (r + R)I$$

$I = \frac{E}{(r + R)}$  is the intensity of the current flowing in the circuit according to Ohm’s law.

Step 7: Assign the learners to work through examples in the learner’s book page 216.

### Lesson Flow

- Let the learners carry out the related activity in learner’s book (if it is a mixed school, the number of boys and girls in each group should be balanced).
- Put learners in groups (select any number of learners depending on the size of the class) make sure that they work in harmony.
- Help them in selecting their group leaders.
- Identify learners with special needs in group making. Encourage them to actively participate in their respective groups.
- Move around the class guiding learners as they are performing the activity. In case of any assistance you can make bright learners to assist the weak ones.
- Let the learners discuss their findings in their groups and finally present to the whole class.

- Consolidate the lesson by developing and giving your ideas basing on learners' ideas.

### **Note**

Help the learners to work neatly and systematically.

### **Assessment criteria**

Learners may be assessed using the following methods;

- by asking them oral questions.
- making learners to work out activities.
- check and mark work of each learner.

The methods mentioned above can be varied. The use of a particular method depends on the size of the class, level of learners, availability of scholastic materials, time of the day and the moods of the learners.

### **References**

Learner's book 4 (Physics for Rwanda Secondary Schools Book 4)

Other available Physics books in the school library.

## **Lesson 7: Combination of cells, Combination of cells (Interpretation of experimental results)**

Period 7: (80 Minutes)

Combination in series and parallel. Mixing a series and a parallel combination.

### **Combination of cells**

- Step 1: Carry out activity 11 page 217. Let learners work through this activity step by step answering different suggested questions and writing what they are observing as asked in the procedure.
- Step 2: Discuss with the learners the results of their findings. Make sure that learners make corrections to any false finding.
- Step 3: After the activity, a copy of what was done should be submitted to you by learners because this will help in interpretation and this will be helpful in case the next lesson is not consecutive to the one of the activity.
- Step 4: Before winding up with the lesson, guide the learners to discover that what they found are experimental result which can be interpreted mathematically.

**Combination of cells (Interpretation of experimental results)  
Combination in series and opposition**

- Step 1: Give back to learners work submitted in previous activity so that it helps them to check and verify the correspondence of the mathematical result and experimental result.
- Step 2: When establishing relations, read questions on the previous activity and learners will be giving answers found in the activity.
- Step 3: Apply the laws of circuits as studied. For example, in series, the voltage at terminals of the combination is the sum of voltages in different parts of the circuit but the intensity of the current is the same in the circuit. In opposition, the two cells have a tendency to send the current in opposite directions and because the two emfs are equal, there was no current flow but in the case of one battery, has an emf greater than the other; it can send the current through the other.

Consider the case that resistors are conductors for that reason for the two cases, resistances are in series. So, to find internal resistances, we just consider resistances in series.

- Step 4: Let learners do questions suggested in order to help them to retain relations.
- Step 5: Emphasise on the case that batteries are connected in series in order to increase the emf and total resistance.
- Step 6: Give some different cases in which the series combination is applied. For example in a radio, etc.
- Step 7: The teacher should guide the learners to discover how a combination of batteries in opposition is applied (see learner's book).

**Combination of cells (Interpretation of experimental results)  
Combination in parallel and mixing a series and a parallel combination**

- Step 1: Give back to learners work submitted in previous activity so that it helps them to check and verify the corresponding of the mathematical result and experimental result.
- Step 2: When establishing relations, read questions on the previous activity and learners will be giving answers found in the activity.

- Step 3: Apply the laws of circuits as studied. For example, in parallel, the intensity of the current at terminals of the combination is the sum of intensities in different branches of the circuit but the voltage is the same at terminals of the circuit.
- Step 4: Lead the learners to discover that only identical cells can be connected in parallel.
- Step 5: The teacher will lead the learners that for some purposes some electric circuits can have a mixture of series and parallel combinations. Each series will be considered as one battery having an emf and an internal resistance and all constituting series have same characteristics.
- Step 6: Let learners work through suggested exercises and help them in the case of a problem.

### **Lesson Flow**

- Let the learners work through the related activity in learner's book (if it is a mixed school, the number of boys and girls in each group should be balanced).
- Put learners in groups (select any number of learners depending on the size of the class) make sure that they work in harmony.
- Help them in selecting their group leaders.
- Identify learners with special needs in group making. Encourage them to actively participate in their respective groups.
- Move around the class guiding learners as they are performing the activity. In case of any assistance you can make bright learners to assist the weak ones.
- Let the learners discuss their findings in their groups and finally present to the whole class.
- Consolidate the lesson by developing and giving your ideas basing on learners' ideas.

### **Note**

Help the learners to work neatly and systematically.

### **Assessment criteria**

Learners may be assessed using the following methods;

- by asking them oral questions.



- making learners to work out activities.
- check and mark work of each learner.

The methods mentioned above can be varied. The use of a particular method depends on the size of the class, level of learners, availability of scholastic materials, time of the day and the moods of the learners.

### References

Learner's book 4 (Physics for Rwanda Secondary Schools Book 4)  
Other available Physics books in the school library.

## Lesson 8: Receptors: Back electromotive force, Internal resistance

Period 8: (40 Minutes)

- Step 1: Let learners **do activity 12** page 226. They observe the picture and answer questions.
- Step 2: **Some suggested answers:** (a) TV set, radio, fridge, electric motor, kettle, iron, cooker, telephone, hair dryer. (c) No, there are those which transform the whole energy consumed in heat and there are some which transform a part of electric energy in another type of energy which is not heat. (d) Those which transform the total electric energy in heat are: iron, kettle, cooker and others are for the other case. (e) The back emf and internal resistance.
- Step 3: Provide a conclusion which is in the learner's book page 222.
- Step 4: Show that the internal resistance is defined in the same way as for generators.

### The p.d at terminals of a receptor

- Step 1: Instruct learners to carry out activity 13 page 228. Learners will perform this activity in step by step recording data and answering different suggested questions as asked in the procedure.
- Step 2: Guiding the learners because wrong results on this can affect results in interpretation.
- Step 3: As done for the case of a cell, guide the learners to develop the information below (Interpretation).

Step 4: After the lesson, assign homework to learners which will be working through exercises on pages 229 and 230.

### Interpretation

Let  $P_J$  be the power converted into heat by Joule effect

$P'$  be the power converted into another type of energy which is not heat.

The total power consumed by the motor (receptor) is given by:

$$P = P' + P_J$$

$$VI = E'I + I^2r'$$

$$VI = I(E' + Ir') \Rightarrow v = E' + Ir'$$

From the relation above  $V > E'$

The intensity of the current is therefore given by:  $I = \frac{V - E'}{r'}$

### Functioning Condition

For a circuit having a receptor and a generator, the following condition must be respected:  $E > V > E$ .

### Lesson Flow

- Let the learners carry out the related activity in learner's book (if it is a mixed school, the number of boys and girls in each group should be balanced).
- Put learners in groups (select any number of learners depending on the size of the class) make sure that they work in harmony.
- Help them in selecting their group leaders.
- Identify learners with special needs in group making. Encourage them to actively participate in their respective groups.
- Move around the class guiding learners as they are performing the activity. In case of any assistance you can make bright learners to assist the weak ones.
- Let the learners discuss their findings in their groups and finally present to the whole class.
- Consolidate the lesson by developing and giving your ideas basing on learners' ideas.

### **Note**

Help the learners to work neatly and systematically.

### **Assessment criteria**

Learners may be assessed using the following methods;

- by asking them oral questions.
- making learners to work out activities.
- check and mark work of each learner.

The methods mentioned above can be varied. The use of a particular method depends on the size of the class, level of learners, availability of scholastic materials, time of the day and the moods of the learners.

### **References**

Learner's book 4 (Physics for Rwanda Secondary Schools Book 4)

Other available Physics books in the school library.

## **Lesson 9: Generators and receptors: Exercises**

Period 9: (160 Minutes)

### **Exercises**

In general,

- Step 1: It's better that if you know you have a lesson together with a set of exercises, leave questions to learners as homework. Let learners think deeply about them at home and during the lesson. They can discuss in groups and the teacher should guide the learners to develop conclusion on what they found.
- Step 2: Let the learners discuss given questions in groups and guide them.
- Step 3: Prepare the lesson appropriately. This is the time to revise and to emphasise on what learners have learned. So you can be reminding learners what you taught related to the step in question.
- Step 4: You are not obliged to solve all questions in the learner's book. Solve some and leave others to learners as homework.
- Step 5: In preparing the lesson, choose other questions even outside the learner's book; the purpose is to raise the level of understanding of the learners. Know the level, and their weakness to strengthen them.

Step 6: Develop methods of solving exercises based on the level of learners.

### **Lesson Flow**

- Let the learners do the related activity in learner's book (if it is a mixed school, the number of boys and girls in each group should be balanced).
- Put learners in groups (select any number of learners depending on the size of the class) make sure that they work in harmony.
- Help them in selecting their group leaders.
- Identify learners with special needs in group making. Encourage them to actively participate in their respective groups.
- Move around the class guiding learners as they are performing the activity. In case of any assistance you can make bright learners to assist the weak ones.
- Let the learners discuss their findings in their groups and finally present to the whole class.
- Consolidate the lesson by developing and giving your ideas basing on learners' ideas.

### **Note**

Help the learners to work neatly and systematically.

### **Assessment criteria**

Learners may be assessed using the following methods;

- by asking them oral questions.
- making learners to work out activities.
- check and mark work of each learner.

The methods mentioned above can be varied. The use of a particular method depends on the size of the class, level of learners, availability of scholastic materials, time of the day and the moods of the learners.

## Lesson 10: Kirchhoff's rules

Period 10: (80 Minutes)

### Introduction

- Step 1: Instruct learners to carry out activity 14 page 230. Learners carry out the experiment step by step, record data and answer questions as asked in the procedure.
- Step 2: After the activity, let learners submit their work to you. The purpose of this activity is to remind learners about combinations of resistances.
- Step 3: Review their knowledge of the general formulae of resistances in series and in parallel.
- Step 4: In order to introduce this lesson, the teacher can show two circuits represented by diagrams below (a) and (b). Show that for (a) it's possible and easy to calculate the current flowing in the circuit using general method and but for (b) it's more challenging to calculate the currents without knowing methods; so we use other new rules called Kirchhoff's rules which will be studied in the next lesson.

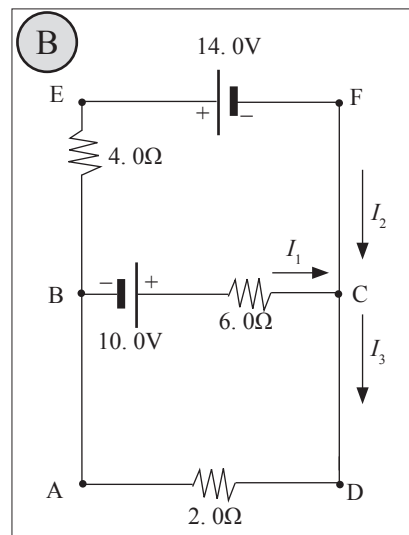
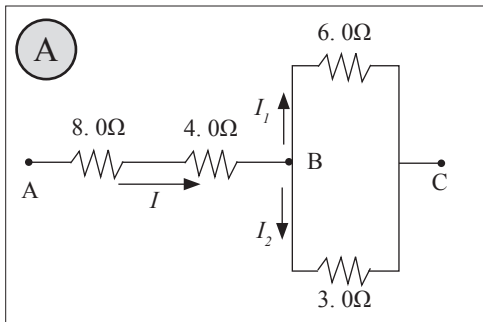

### Kirchhoff's rules

- Step 1: Guide the learners to discover that it's easy and possible to know characteristics of the first circuit using general methods but the second requires other skills which must be learned and followed with attention.

Step 2: The teacher through the use of thought provoking questions, lead the learners to develop the rules to learners as in the learner's book. He'll give also notes to learners about just those rules.

### Information for the teacher

- Figure 5.32(b) in the learner's book represents a mechanical analog of this situation, in which water flows through a branched pipe having no leaks. Because water does not build up anywhere in the pipe, the flow rate into the pipe equals the total flow rate out of the two branches on the right.
- When applying Kirchhoff's second rule in practice, we imagine *travelling* around the loop and consider changes in *electric potential*, rather than the changes in *potential energy* described in the preceding paragraph. You should note the following sign conventions when using the second rule:
  - Because charges move from the high-potential end of a resistor towards the low potential end, if a resistor is traversed in the direction of the current, the potential difference  $V$  across the resistor is  $-IR$  (Fig. 5.32 (a)).
  - If a resistor is traversed in the direction opposite the current, the potential difference  $V$  across the resistor is  $+IR$  (Fig. 5.32 (b)).
  - If a source of emf (assumed to have zero internal resistance) is traversed in the direction of the emf (from  $+$  to  $-$ ), the potential difference  $V$  is  $-E$ . The emf of the battery increases the electric potential as we move through it in this direction.
  - If a source of emf (assumed to have zero internal resistance) is traversed in the direction opposite the emf (from  $-$  to  $+$ ), the potential difference  $V$  is  $+E$ . In this case the emf of the battery reduces the electric potential as we move through it.
- Limitations exist on the numbers of times you can usefully apply Kirchhoff's rules in analysing a circuit. You can use the junction rule as often as you need, so long as each time you write an equation you include in it a current that has not been used in a preceding junction-rule equation. In general, the number of times you can use the junction rule is one fewer than the number of junction points in the circuit. You can apply the loop rule as often as needed, as long as a new circuit element (resistor

or battery) or a new current appears in each new equation. In general, in order to solve a particular circuit problem, the number of independent equations you need to obtain from the two rules equals the number of unknown currents.

Step 3: Consider examples given in the learner's book page 234 and guide learners to solve them. Suggested procedure and answers are below:

### Solution example 1

- (a) We do not need Kirchhoff's rules to analyse this simple circuit, but let us use them anyway just to see how they are applied. There are no junctions in this single-loop circuit; thus, the current is the same in all elements. Let us assume that the current is clockwise, as shown in Figure in the question. Traversing the circuit in the clockwise direction, starting at a, we see that  $A \rightarrow B$  represents a potential difference of  $+E_1$ ,  $B \rightarrow C$  represents a potential difference of  $-IR_1$ ,  $C \rightarrow D$  represents a potential difference of  $-E_2$ , and  $D \rightarrow A$  represents a potential difference of  $-IR_2$ . Applying Kirchhoff's loop rule gives:

$$\sum \Delta V = 0 \Rightarrow E_1 - IR_1 - E_2 - IR_2 = 0$$

Solving for I and using the values given in the Figure, we obtain:

$$I = \frac{E_1 - E_2}{R_1 + R_2} = \frac{6 - 12}{8 + 10} = -0.33 \text{ A} \quad (1)$$

The negative sign for I indicates that the direction of the current is opposite the assumed direction. Notice that the emfs in the numerator subtract because the batteries have opposite polarities. In the denominator, the resistances add because the two resistors are in series.

- (b) Using the relation of the power dissipated as heat in a resistor, we have:

$$P_1 = I^2 R_1 = (0.33)^2 (8.0) = 0.87 \text{ W}$$

$$P_2 = I^2 R_2 = (0.33)^2 (8.0) = 0.87 \text{ W}$$

Hence, the total power delivered to the resistors is  $P_1 + P_2 = 2 \text{ W}$ .

The 12V battery delivers power  $IE_2 = 4 \text{ W}$ . Half of this power is delivered to the two resistors, as we just calculated.

The other half is delivered to the 6V battery, which is being charged by the 12V battery. If we had included the internal resistances of the batteries in our analysis, some of the power would appear as internal energy in the batteries; as a result, we would have found that less power was being delivered to the 6V battery.

What if the polarity of the 12V battery were reversed? How would this affect the circuit?

Answer: While we could repeat the Kirchhoff's rules calculation, let us examine Equation (1) and modify it accordingly. Because the polarities of the two batteries are now in the same direction, the signs of 1 and 2 are the same and Equation (1) becomes:

$$I = \frac{E_1 + E_2}{R_1 + R_2} = \frac{6 + 12}{8 + 10} = 0.1 \text{ A} \quad (1)$$

The new powers delivered to the resistors are:

$$P_1 = I^2 R_1 = (1.0)^2 (8.0) = 8.07 \text{ W}$$

$$P_2 = I^2 R_2 = (1.0)^2 (10) = 10 \text{ W}$$

This totals 18W, nine times as much as in the original circuit, in which the batteries were opposing each other.

### Solution example 2

Conceptualise by noting that we cannot simplify the circuit by the rules of adding resistances in series and in parallel. (If the 10V battery were taken away, we could reduce the remaining circuit with series and parallel combinations).

Thus, we categorize this problem as one in which we must use Kirchhoff's rules. To analyse the circuit, we arbitrarily choose the directions of the currents as labeled in Figure. Applying Kirchhoff's junction rule to junction C gives.

$$I_1 + I_2 = I_3 \quad (1)$$

We now have one equation with three unknowns,  $I_1$ ,  $I_2$ , and  $I_3$ . There are three loops in the circuit, ABCDA, BEFCB, and AEFDA. We therefore need only two loop equations to determine the unknown currents. (The third loop equation would give no new information).



Applying Kirchhoff's loop rule to loops ABCDA and BEFCB and traversing these loops clockwise, we obtain the expressions

$$\text{ABCD A: } 10.0 - 6.0 I_1 - 2.0 I_3 = 0 \quad (2)$$

$$\text{BEFCB: } -14.0 + 6.0 I_1 - 10.0 - 4.0 I_2 = 0 \quad (3)$$

**Note** that in loop BEFCB we obtain a positive value when traversing the  $6\Omega$  resistor because our direction of travel is opposite the assumed direction of  $I_1$ . Expressions (1), (2), and (3) represent three independent equations with three unknowns. Substituting Equation (1) into Equation (2) gives

$$10.0 - 6.0 I_1 - 2.0 (I_1 + I_2) = 0$$

$$10.0 = 8.0 I_1 + 2.0 I_2 \quad (4)$$

Dividing each term in Equation (3) by 2 and rearranging gives

$$-12.0 = -3.0 I_1 + 2.0 I_2 \quad (5)$$

Subtracting Equation (5) from Equation (4) eliminates  $I_2$ , giving

$$22.0 = 11.0 I_1, \text{ We find } I_1 = 2\text{A}$$

Using this value of  $I_1$  in Equation (5) gives a value for  $I_2$ :

$$2.0 I_2 = 3.0 I_1 - 12.0 = 3.0 \times 2.0 - 12.0 = -6.0. \text{ Then } I_2 = -3\text{A}$$

Finally,

$$I_3 = I_1 + I_2 = -1\text{A}$$

To finalize the problem, note that  $I_2$  and  $I_3$  are both negative. This indicates only that the currents are opposite the direction we chose for them. However, the numerical values are correct. What would have happened had we left the current directions as labeled in Figure but traversed the loops in the opposite direction?

### Solution example 3

- (a) First note that because the capacitor represents an open circuit, there is no current between G and B along path GHAB under steady-state conditions. Therefore, when the charges associated with  $I_1$  reach point G, they all go toward point B through the  $8.00\text{-V}$  battery; hence,  $I_{\text{GB}} = I_1$ .

Labelling the currents as shown in the figure and applying the junction rule to junction C, we obtain

$$I_1 + I_2 = I_3 \quad (1)$$

Loops' rule applied to loops DEFCD and CFGBC, traversed clockwise, gives

$$\text{DEFCD: } 4.00 - 3.00 I_2 - 5.00 I_3 = 0 \quad (2)$$

$$\text{CFGBC: } 3.00 I_2 - 5.00 I_1 + 8.00 = 0 \quad (3)$$

From Equation (1) we see that  $I_1 = I_3 - I_2$ , which, when substituted into Equation (3), gives  $8.00 I_2 - 5.00 I_3 + 8.00 = 0$  (4)

Subtracting Equation (4) from Equation (2), we eliminate  $I_3$  and find that

$$I_2 = -\frac{4.4}{11.0} = -0.364\text{A}, I_2 = -0.364\text{A}$$

Because our value for  $I_2$  is negative, we conclude that the direction of  $I_2$  is from C to F in the  $3\Omega$  resistor. Despite this interpretation of the direction, however, we must continue to use this negative value for  $I_2$  in subsequent calculations because our equations were established with our original choice of direction.

Using  $I_2 = 0.364\text{A}$  in Equations (3) and (1) gives

$$I_1 = 1.38\text{A} \text{ and } I_3 = 1.02\text{A}$$

- (b) We can apply Kirchhoff's loop rule to loop BGHAB (or any other loop that contains the capacitor) to find the potential difference  $\Delta V_{\text{CAP}}$  across the capacitor. We use this potential difference in the loop equation without reference to a sign convention because the charge on the capacitor depends only on the magnitude of the potential difference.

Moving clockwise around this loop, we obtain

$$-8.00 + \Delta V_{\text{CAP}} - 3.00 = 0, \text{ then } \Delta V_{\text{CAP}} = 11\text{V}$$

Because  $Q = C \Delta V_{\text{CAP}}$ , the charge on the capacitor is  $Q = (6.00)(11.0\text{V}) = 66.0 \mu\text{F}$

Step 4: After that, give homework in order to retain that. Because if they don't work on it, they can forget how to apply them. The checking will be done in the following lesson.

### **Lesson Flow**

- Let the learners carry out the related activity in learner's book (if it is a mixed school, the boys and girls in each group should be balanced).
- Put learners in groups (select any number of learners depending on the size of the class) make sure that they work in harmony.
- Help them in selecting their group leaders.
- Identify learners with special needs in group making. Encourage them to actively participate in their respective groups.
- Move around the class guiding learners as they are performing the activity. In case of any assistance you can make bright learners to assist the weak ones.
- Let the learners discuss their findings in their groups and finally present to the whole class.
- Consolidate the lesson by developing and giving your ideas basing on learners' ideas.

### **Note**

Help the learners to work neatly and systematically.

### **Assessment criteria**

Learners may be assessed using the following methods;

- by asking them oral questions.
- making learners to work out activities.
- check and mark work of each learner.

The methods mentioned above can be varied. The use of a particular method depends on the size of the class, level of learners, availability of scholastic materials, time of the day and the moods of the learners.

## Lesson 11: Kirchhoff's rules

---

Period 11: (120 Minutes)

### Exercises

- Step 1: If you have a lesson together with a set of exercises, leave questions to learners as homework. Let learners think deeply about them at home and during the lesson let them discuss in groups and the teacher should guide the learners to develop conclusion on what they found.
- Step 2: Put learners in groups and let them discuss given questions in groups and guide them to common solution.
- Step 3: Prepare an appropriate lesson. This is the time to revise and to emphasise on what learners have learned. So remind the learners what you taught related to the step in question.
- Step 4: You are not obliged to do all questions in the learner's book. Do some and leave others to learners as homework.
- Step 5: In preparing the lesson, choose other questions even outside the learner's book; the purpose is to raise the level of understanding of learners. Know the level, their weakness and strengthen them.
- Step 6: Develop methods of solving exercises based on the level of learners.

### Lesson Flow

- Let the learners do the related activity in learner's book (if it is a mixed school, the number of boys and girls in each group should be balanced).

## UNIT 6

# Sources of Energy in the World

**Learner's book pages 241-265**

**Key unit competence:** By the end of the unit, the learner should be able to evaluate energy sources in the world



### Learning objectives

---

Learners should be able to:

- have a general idea about energy and source of energy.
- list different sources of energy and their definitions.
- differentiate renewable energy from non-renewable energy
- identify energy sources in the world.
- explain what happens to the renewable/non-renewable energy sources that remain after many years of energy use.
- describe renewable and non-renewable energy and sources of energy in Rwanda.
- explain the contribution of solar energy to other energies.
- describe how renewable and non-renewable energies are created and extracted.
- define relationships that demonstrate or validate theory, and to critically evaluate the adequacy of model output in comparison with the complexities of nature.

This unit is to be taught in 20 lessons, each of 40minutes

Evaluation must be done during the allocated time

### Unit Breakdown

Serial number	Lesson title	Number of minutes	Periods
1	World energy sources	80	2
2	Renew A bead activity	80	2
3	Fossil fuel, Nuclear energy, Renewable energy	240	6
4	Advantages and disadvantages of renewable and non-renewable energy. The sun, prime energy source of world energy.	80	2
5	Creation and extraction of renewable and non-renewable energy	80	2
6	Visits and field studies	240	6
	Total	800	20

#### Lesson 1: World energy sources

Period 1: (80 Minutes)

Step 1: Group the learners and instruct learners to carry out activity 1 page 242 step by step and to answer questions. In the activity, there are some definitions in the table which must be understood by learners. This will help them in the continuation and other activities.

Step 2: Let learners submit their work to you and follow the method described below to teach them.

- Ask learners what they think of when they hear the word “energy.” Write down their answers. (Many learners will likely think first about their own personal energy; e. g. , “I don’t have much energy today. ”)
- Guide the class, come up with a definition for the word “energy” and the term “energy source. ” Standard definitions are:
  - Energy: The ability to do work, or the cause of all activity.
  - Energy source: Something that can be tapped to provide heat, chemical, mechanical, nuclear, or radiant energy.

- Have the learners list as many energy sources as they can. Write this list on the blackboard. Among scientists and energy professionals, a standard list of current energy sources would include: biomass (plant matter), nuclear, coal, oil, geothermal, solar, hydro (rivers), wave or tidal, natural gas, wind. Your learners may come up with some variations on this list or additions to it that are also acceptable: animal energy, food, propane, batteries, gasoline, water, charcoal, human energy, wood.
- Guide the learners to develop a list of energy sources and arrange them into two categories: renewable and non-renewable. Guide them to develop the following definitions:
  - Renewable – Energy sources that are replaced by natural processes at a rate comparable to their use.
  - Non-renewable – Energy sources that are limited and can eventually run out; these sources of energy cannot be replaced on a timespan of human significance.
- Ask the learners to use these definitions to decide which of their energy sources are renewable and which are non-renewable. You may wish to provide learners with some of the following information: The major examples of renewable energy sources are solar, wind, hydro, and biomass (plant matter).
- Lead the learners to develop conclusions that in contrast to fossil fuels, renewable sources of energy produce little or no pollution or hazardous waste and pose few risks to public safety. Furthermore, they are an entirely domestic resource. Long before we actually run out of coal, oil, or gas, however, the environmental and social consequences of extracting, processing, transporting, and burning fossil fuels may become intolerable. In addition, it will not be economically viable to extract all of our fossil fuels, as renewable resources will eventually become competitive.
- Ask learners to list as many current uses of renewable energy sources as they can. Answers can range from small devices like solar-powered calculators to large-scale production of electricity from hydroelectric dams to occasional uses like wood for cooking on camping trips and wind for sailboats.

### **Lesson Flow**

Let the learners carry out the related activity in learner's book (if it is a mixed school, the number of boys and girls in each group should be balanced).

Put learners in groups (select any number of learners depending on the size of the class) make sure that they work in harmony.

Help them in selecting their group leaders.

Identify learners with special needs in group making. Encourage them to actively participate in their respective groups.

Move around the class guiding learners as they are performing the activity. In case of any assistance you can make bright learners to assist the weak ones.

Let the learners discuss their findings in their groups and finally present to the whole class.

Consolidate the lesson by developing and giving your ideas basing on learners' ideas.

### **Note**

Help the learners to work neatly and systematically.

### **Assessment criteria**

Learners may be assessed using the following methods;

- by asking them oral questions.
- making learners to work out activities.
- check and mark work of each learner.

The methods mentioned above can be varied. The use of a particular method depends on the size of the class, level of learners, availability of scholastic materials, time of the day and the moods of the learners.

## **Lesson 2: World energy sources**

---

Period 2: (80 Minutes)

Renew a bead activity



- Step 1: Group the learners and set them to work through activity 2 page 244 step by step and answer questions, then fill in tables, and analyse data. Let them discuss results in group, and carry out calculations, etc.
- Step 2: Be careful because this activity requires many skills at the same time. It's very long, do your best in order not to come back to it several times. It means you can be following all steps and make sure everything is correct.
- Step 3: Use at least one hour for data collection and calculation and another one for discussion.

### **Lesson Flow**

Let the learners carry out the related activity in learner's book (if it is a mixed school, the number of boys and girls in each group should be balanced).

Put learners in groups (select any number of learners depending on the size of the class) make sure that they work in harmony.

Help them in selecting their group leaders.

Identify learners with special needs in group making. Encourage them to actively participate in their respective groups.

Move around the class guiding learners as they are performing the activity. In case of any assistance you can make bright learners to assist the weak ones.

Let the learners discuss their findings in their groups and finally present to the whole class.

Consolidate the lesson by developing and giving your ideas basing on learners' ideas.

### **Note**

Help the learners to work neatly and systematically.

### **Assessment criteria**

Learners may be assessed using the following methods;

- by asking them oral questions.

- making learners to work out activities
- check and mark work of each learner.

The methods mentioned above can be varied. The use of a particular method depends on the size of the class, level of learners, availability of scholastic materials, time of the day and the moods of the learners.

### **Lesson 3: World energy sources**

---

Period 3: (240 Minutes)

- Fossil fuel
- Nuclear energy
- Renewable energy

Step 1: In this lesson the activity will be of reading. Let learners carry out activity 3. In groups, let them read and give explanation to each other. Let them discuss what is written. The purpose is to learn more about sources of energy. They'll be learning also about sources of energy in Rwanda at the same time. Here learners, in case of a problem in understanding, will try to help each other in groups.

Step 2: Let this activity be carried out two times. The first one is to read the material in the learner's book and the second carry out research on internet in order to add more knowledge. That will be in the following lesson.

Step 3: Follow carefully this activity. Make sure that learners are really learning and explanations are effective in groups. Emphasise more about sources in Rwanda.

- Fossil fuel
- Nuclear energy
- Renewable energy

Step 1: Applying what they have read, learners will carry out activity 4 and activity 5. In groups, they'll follow step by step, and answer different questions.

Step 2: Monitor carefully this activities.

Step 3: In the table of activity 5, suggested answers are below. This will serve also as answers for the next activity.

Energy source	Advantages	Disadvantages
Biomass	<ul style="list-style-type: none"> <li>• Abundant and renewable.</li> <li>• Can be used to burn waste products.</li> </ul>	<ul style="list-style-type: none"> <li>• Burning biomass can result in air pollution.</li> <li>• May not be cost effective.</li> <li>• May result in deforestation.</li> </ul>
Fossil fuels	<ul style="list-style-type: none"> <li>• Available in plenty.</li> <li>• Easier to find.</li> <li>• Extremely efficient.</li> <li>• Easier to transport.</li> <li>• Generate thousands jobs.</li> <li>• Easy to set up.</li> </ul>	<ul style="list-style-type: none"> <li>• Environment degradation.</li> <li>• Need truckloads of reserves.</li> <li>• Public health issues.</li> <li>• Finite energy source.</li> <li>• Rising cost.</li> <li>• Health of coal-mining workers.</li> </ul>
Geothermal	<ul style="list-style-type: none"> <li>• Provides an unlimited supply of energy.</li> <li>• Produces no air or water pollution.</li> </ul>	<ul style="list-style-type: none"> <li>• Start-up/development costs can be expensive.</li> <li>• Maintenance costs, due to corrosion, can be a problem.</li> </ul>
Hydropower	<ul style="list-style-type: none"> <li>• Abundant, clean, and safe.</li> <li>• Easily stored in reservoirs.</li> <li>• Relatively inexpensive way to produce electricity.</li> <li>• Offers recreational benefits like boating, fishing, etc.</li> </ul>	<ul style="list-style-type: none"> <li>• Can have a significant environmental impact.</li> <li>• Can be used only where there is a continuous water flow.</li> <li>• Best sites for dams have already been developed.</li> </ul>
Nuclear	<ul style="list-style-type: none"> <li>• Lower greenhouse gas emissions.</li> <li>• Powerful and efficient.</li> <li>• They can produce power continuously and need to be shut down for maintenance purpose only. We say they are reliable.</li> <li>• Cheap electricity.</li> <li>• Low fuel cost.</li> <li>• Easy transportation.</li> </ul>	<ul style="list-style-type: none"> <li>• High construction costs due to complex radiation containment systems and procedures.</li> <li>• High subsidies needed for construction and operation, as well as loan guarantees.</li> <li>• High-known risks in an accident.</li> <li>• Unknown risks.</li> <li>• Long construction time.</li> <li>• Target for terrorism (as are all centralized power generation sources).</li> </ul>

Energy source	Advantages	Disadvantages
Solar	<ul style="list-style-type: none"><li>• Unlimited supply.</li><li>• Causes no air or water pollution.</li></ul>	<ul style="list-style-type: none"><li>• May not be cost effective.</li><li>• Storage and backup are necessary.</li><li>• Reliability depends on availability of sunlight.</li></ul>
Wind	<ul style="list-style-type: none"><li>• Is a “free” source of energy.</li><li>• Produces no water or air pollution.</li><li>• Wind farms are relatively inexpensive to build.</li><li>• Land around wind farms can have other uses.</li></ul>	<ul style="list-style-type: none"><li>• Requires constant and significant amounts of wind.</li><li>• Wind farms require significant amounts of land.</li><li>• Can have a significant visual impact on landscapes.</li></ul>

In the case of problems in these activities, the teacher can allow learners to access internet again.

### Lesson Flow

Let the learners carry out the related activity in learner's book (if it is a mixed school, the number of boys and girls in each group should be balanced).

Put learners in groups (select any number of learners depending on the size of the class) make sure that they work in harmony.

Help them in selecting their group leaders.

Identify learners with special needs in group making. Encourage them to actively participate in their respective groups.

Move around the class guiding learners as they are performing the activity. In case of any assistance you can make bright learners to assist the weak ones.

Let the learners discuss their findings in their groups and finally present to the whole class.

Consolidate the lesson by developing and giving your ideas basing on learners' ideas.

**Note**

Help the learners to work neatly and systematically.

**Assessment criteria**

Learners may be assessed using the following methods;

- by asking them oral questions.
- making learners to work out activities.
- check and mark work of each learner.

The methods mentioned above can be varied. The use of a particular method depends on the size of the class, level of learners, availability of scholastic materials, time of the day and the moods of the learners.

**Lesson 4: Advantages and disadvantages of renewable and non-renewable energy, the sun, prime energy source of world energy**

Period 4: (80 Minutes)

- Step 1: Instruct learners to carry out activity 6 page 262. In groups, let them follow step by step, answer different questions. This activity is like a summary of what was already done. Answers have been given already. Let learners work without any support, Books, internet, etc. By your will, it can be even a quiz.
- Step 2: In this lesson, the teacher will guide the learners to discover that the sun is the prime source of energy and contributes a lot to other sources. She/He'll give the information which is at the page 257 of the learner's book.

**Lesson Flow**

Let the learners do the related activity in learner's book (if it is a mixed school, the number of boys and girls in each group should be balanced).

Put learners in groups (select any number of learners depending on the size of the class) make sure that they work in harmony.

Help them in selecting their group leaders.

Identify learners with special needs in group making. Encourage them to actively participate in their respective groups.

Move around the class guiding learners as they are performing the activity. In case of any assistance you can make bright learners to assist the weak ones.

Let the learners discuss their findings in their groups and finally present to the whole class.

Consolidate the lesson by developing and giving your ideas basing on learners' ideas.

### **Note**

Help the learners to work neatly and systematically.

### **Assessment criteria**

Learners may be assessed using the following methods;

- by asking them oral questions.
- making learners to work out activities.
- check and mark work of each learner.

The methods mentioned above can be varied. The use of a particular method depends on the size of the class, level of learners, availability of scholastic materials, time of the day and the moods of the learners.

## **Lesson 5: Creation and extraction of renewable and non-renewable energy**

---

Period 5: (80 Minutes)

Step 1: Set learners to carry out activity 7 page 263. Let them learn in detail how renewable and non renewable energy is created. Let them give also some different ways to extract them.

Step 2: The table below contains some suggested answers for the creation and extraction. For the extraction of different types of energy, the teacher will judge the accuracy of them.

Step 3: After, the teacher will summarise giving information on page 264-265.

Energy	Creation	Extraction
Solar	Is produced in the core of the sun. In a process called nuclear fusion, the intense heat in the sun causes hydrogen atoms to break apart and fuse together to form helium atoms. A very small amount of mass is lost in this process.	Already talked about
Hydropower	Is energy that comes from the force of moving water. Hydropower is a renewable energy source because it is replenished constantly by the fall and flow of snow and rainfall in the water cycle.	As water flows through devices such as a water wheel or turbine, the kinetic (motion) energy of the water is converted to mechanical energy, which can be used to grind grain, drive a sawmill, pump water, or produce electricity.
Wind	Wind is air in motion. It is caused by the uneven heating of the earth's surface by the sun.	Wind power has been used for thousands of years to convert the wind's kinetic (motion) energy into mechanical energy for grinding grain or pumping water. Today, wind machines are used increasingly to produce electricity.
Geothermal	Geothermal energy comes from the intense heat within the earth. The heat is produced by the radioactive decay of elements below the earth's surface.	Hydrothermal energy has two basic ingredients: water and heat. Water beneath the earth's surface contacts the heated rocks and changes into steam. Depending on the steam's temperature, it can heat buildings directly or can power turbines to generate electricity.
Biomass	Biomass is any organic substance that can be used as an energy source. The most common examples are wood, crops, seaweed, and animal wastes.	The energy is stored in biomass through the process of photosynthesis, in which plants combine carbon dioxide, water, and certain minerals to form carbohydrates. The most common way to release the energy from biomass is burning. Other less used ways are bacterial decay, fermentation, and conversion.

Energy	Creation	Extraction
Fossil fuel	It is almost impossible to ignore fossil fuel use in the world today. Fossil fuels come in three main forms: coal, natural gas and petroleum (oil). Fossil fuels were created by dead organic matter millions of years ago.	Extraction produces raw material which is then processed to add value. Examples of extractive industries are hunting, trapping, mining, oil and gas drilling, and forestry.

### Lesson 6-20: Visits and field studies

Period 6-20: (240 Minutes)

This lesson is for the whole of the remaining periods

- Step 1: A part of the remaining time can help you to cover what you didn't in the normal time due to some circumstances.
- Step 2: The visit (field studies is also an activity. Learners have to leave the school and go to the field to see clearly what they learn in class.
- Step 3: Choose the place and the activity to do according to the availability, the distance of the place. Also the financial situation of the school.
- Step 4: The place and study visits must be related to the curriculum and on subjects in it.

#### You should know this

A field study is a general method for collecting data about users, user needs, and product requirements that involves observation and interviewing. Data are collected about *task* flows, inefficiencies, and the organisational and physical environments of users.

Investigators in field studies observe users as they work, taking notes on particular activities and often asking questions of the users. Observation may be either direct, where the investigator is actually present during the task, or indirect, where the task is viewed by some other means like a video recorder set up in an office. The method is useful early in product development to gather user requirements. It is also useful for studying currently executed tasks and processes.



**Steps in field studies**

- Field studies should be carefully planned and prepared in order to ensure that the data collected is accurate, valid, and collected efficiently. The equipment needed will depend on the type of study being conducted. The process first starts with clearly stating the problem and defining the area of study. From there, a hypothesis, or a theory of explanation, is set forth to explain any occurrences expected for the specified group or phenomena. This is why, before a field study is conducted, it is important to identify the data/phenomena to observe.
- Once the hypothesis has been established, the data can be classified and scaled so that it will be easy to know how to categorize information. Observations are classified because not all field observations will be needed; therefore, the observer can know what to look for and what to disregard. Observations are also scaled to give the observer a way to rank the importance or significance of what has been observed. Once field observations are concluded, this data will be analysed and processed in order to resolve the problem initially presented or to accept or reject the hypothesis that was presented.

## UNIT 7

# Energy Degradation (Dilapidation) and Power Generation

**Learner's book pages 269-275**

**Key unit competence:** By the end of the unit, the learner will be able to analyse energy degradation/dilapidation and power generation



### Learning objectives

---

Learners should be able to:

- explain what energy degradation is.
- describe how electricity is produced by rotating a coil in a magnetic field.
- demonstrate some concepts on thermodynamics.
- describe the importance of the study of thermodynamics.
- illustrate how thermal energy can be changed into work.
- use a system diagram to show how energy is used.
- explain what a Sankey diagram is.
- describe why a Sankey diagram is used.
- show how the flow of energy is illustrated on diagrams.
- draw a Sankey diagram.
- discover relationships that demonstrate or validate theory, and to critically evaluate the adequacy of model output in comparison with the complexities of Nature;
- record their own observations, order their experiences, make decisions and set their own priorities as to what to focus on and what to ignore.
- engage in “authentic” activities done by professionals as first steps towards their development;

This unit is to be taught in 20 lessons, each of 40 minutes.

Evaluation must be done within allocated time.

### Unit Breakdown

Serial number	Lesson title	Number of minutes	Periods
1	Energy degradation Definition of energy degradation/dilapidation Production of electric energy by rotating coils in magnetic field	80	2
2	Conservation of thermal energy into work by single cyclic processes	80	2
3	Conservation of thermal energy into work by single cyclic processes	80	2
4	Energy flow diagram illustrating energy degradation	80	2
5	Energy flow diagram illustrating energy degradation	80	2
6	Visits and field studies	240	6
	Total	800	20

#### Lesson 1: Energy degradation

Period 1: (80 Minutes)

- Definition of energy degradation/dilapidation
- Production of electric energy by rotating coils in magnetic field

Step 1: In this lesson, start by using thought provoking questions to develop the definition of energy degradation. After that lead the students to develop the concept, thermal energy is the most degraded form of energy. Also demonstrate that energy can be transformed from one form to another and is called energy transformation.

Step 2: Instruct learners to carry out activity 1 page 270. In this activity, learners will perform an experiment to investigate how electric energy is produced when a coil rotates in a magnetic field. They follow the instructions in the activity step by step and answering questions in the activity.

Some suggested answers:

- (a) The needle is deflected, first in one direction, then in the other.

- (b) As the magnet moves through the coil, electrons move in the coil. This is an electric current, of course. When this current flows in the winding around the compass, it causes a magnetic field which surround the compass. This magnetic field causes the compass needle to move, just in the same way that bar magnet causes a compass needle to move.
- (c) As one pole of the magnet moves through the winding, the needle moves in one direction. When the other pole of the magnet passes through the winding, the needle moves in the opposite direction. Because, the purpose of the microampere meter, which measures very, very small amounts of current, is to indicate the direction of flow of current in one direction or the other.

Step 3: Learners are not obliged to give exactly the same answers but you can guide them to give similar ones. After the activity, guide the learners to discover that when a coil rotates in a magnetic field there is production of electromotive force; on this basis the production of electricity by alternators, electric dynamos, and other generators of electric current.

Step 4: Let learners carry out activity 2 page 271. Let them respond to questions. From their answers, guide them to develop the following information.

Step 5: Suggested answers and information to give:

- (a) Emergency generators are used in homes, hospitals, and apartment houses; portable generators are used to run farm equipment and amusement park rides, etc.
- (b) Electricity is a very useful form of energy because it can be easily transferred from one place to another, using wires. This makes it much more efficient in terms of time and energy, compared to previous, more commonly used forms of energy like coal. To use energy from coal directly in a house, transporting it will take more energy than transporting electricity. Electricity can be transformed from many different types of energy sources, and all of these types of energy require a generator to convert mechanical energy to electrical energy eventually.

- (c) A charged object moving through a magnetic field will experience a force. In a wire for example, the force causes electrons to move to one end in the wire. This force is called *electromotive force (emf)*. In a generator, a coil rotates in a magnetic field. This rotation causes an induced emf in the coils.

Step 6: Talk about what is on the page 271-272.

### **Lesson Flow**

Let the learners carry out the related activity in learner's book (if it is a mixed school, the number of boys and girls in each group should be balanced).

Put learners in groups (select any number of learners depending on the size of the class) make sure that they work in harmony.

Help them in selecting their group leaders.

Identify learners with special needs in group making. Encourage them to actively participate in their respective groups.

Move around the class guiding learners as they are performing the activity. In case of any assistance you can make bright learners to assist the weak ones.

Let the learners discuss their findings in their groups and finally present to the whole class.

Consolidate the lesson by developing and giving your ideas basing on learners' ideas.

### **Note**

Help the learners to work neatly and systematically.

### **Assessment criteria**

Learners may be assessed using the following methods;

- by asking them oral questions.
- making learners to work out activities.
- check and mark work of each learner.

The methods mentioned above can be varied. The use of a particular method depends on the size of the class, level of learners, availability of scholastic materials, time of the day and the moods of the learners.

## **Lesson 2: Energy degradation**

---

Period 2: (80 Minutes)

Conversion of thermal energy into work by single cyclic processes

Step 1: In this lesson, learners carry out research in the activity 3. Assign to the learners guiding questions on which the research is based. This is to determine how they behave in a situation of having just a general subject.

Step 2: Guide them by orienting in what you want them to do.

## **Lesson 3: Conservation of thermal energy into work by single cyclic processes**

---

Period 3: (80 Minutes)

Step 1: Remind the learners that in the previous lesson learners carried out research following activity 3 page 272 there were guiding questions on which the research was based.

Step 2: Discuss with the learners and lead them to develop a much more appropriate report. The teacher then sets them to study the notes on page 273 in the learner's book.

## **Lesson 4: Energy degradation**

---

Period 4: (80 Minutes)

Energy flow diagram illustrating energy degradation

Step 1: Set learners to work through activity 4 page 274. They will follow the instructions step by step and will answer questions therein.

Step 2: Follow and guide the activity and obtain answers that will be from the result of the learners work.

### **Lesson Flow**

Let the learners carry out the related activity in learner's book (if it is a mixed school, the number of boys and girls in each group should be balanced).

Put learners in groups (select any number of learners depending on the size of the class) make sure that they work in harmony.

Help them in selecting their group leaders.

Identify learners with special needs in group making. Encourage them to actively participate in their respective groups.

Move around the class guiding learners as they are performing the activity. In case of any assistance you can make bright learners to assist the weak ones.

Let the learners discuss their findings in their groups and finally present to the whole class.

Consolidate the lesson by developing and giving your ideas basing on learners' ideas.

### **Note**

Help the learners to work neatly and systematically.

### **Assessment criteria**

Learners may be assessed using the following methods;

- by asking them oral questions.
- making learners to work out activities.
- check and mark work of each learner.

The methods mentioned above can be varied. The use of a particular method depends on the size of the class, level of learners, availability of scholastic materials, time of the day and the moods of the learners.

## **Lesson 5: Energy degradation**

---

Period 5: (80 Minutes)

Energy flow diagram illustrating energy degradation

- Step 1: Set learners to work through activity 5 page 275. Instruct them to search the internet to find answers to the questions posed. They will follow step by step the given instructions and will answer questions.
- Step 2: Follow and guide learners as they carry out the activity. Let them discuss in groups their reports and submit the work.
- Step 3: After the discussion are done with you and at the end, give the summary and information below.

### **What is a Sankey Diagram?**

A Sankey diagram is a graphic illustration of energy, material or money transfers between processes. In relation to this sub-unit, Sankey diagrams can be used to display the flow of energy, i. e. how useful energy is produced.

Usually, the flows are illustrated as arrows. The width of the arrows is proportional to the size of the represented flow. Sankey diagrams are a better way to illustrate which flows represent advantages and what flows are responsible for waste and emissions.

### ***The Sankey Diagram and Work***

When working with Sankey diagrams most physics Sankey diagram are used to examine energy efficiency. But when using the idea of work, consider the Input energy to input work and the useful output energy to output work. This “conversion” holds true the principal of work, energy and the Sankey diagram.

### **How to draw a Sankey Diagram**

A Sankey diagram illustrates an input/output situation. It is drawn to scale - there are lots of variations as to how they are drawn the only thing they have in common is that the width of the ‘arms’ represents the magnitude of energy transferred but the length of the ‘arms’ does not!

Sankey diagrams allow us to visualise flow through a process or system more easily than numerical data can. They show not only the order of changes but also the quantitative distribution of values in the transfers.



Sankey diagrams do add an indisputable expressive power to mathematical rendering of a system. When professionally constructed, Sankey diagrams represent flow in a manner that can be understood by anyone, instantly.

However, Sankey diagrams can be difficult, time-consuming, and uninteresting, to produce by hand - very tedious to draw! The benefits of being able to generate these diagrams automatically, anytime, are obvious to anyone who has tried to draw one and commercial computer packages for their production are available. They are used not only in physics and engineering to demonstrate how energy is distributed but also for cash flow in businesses.

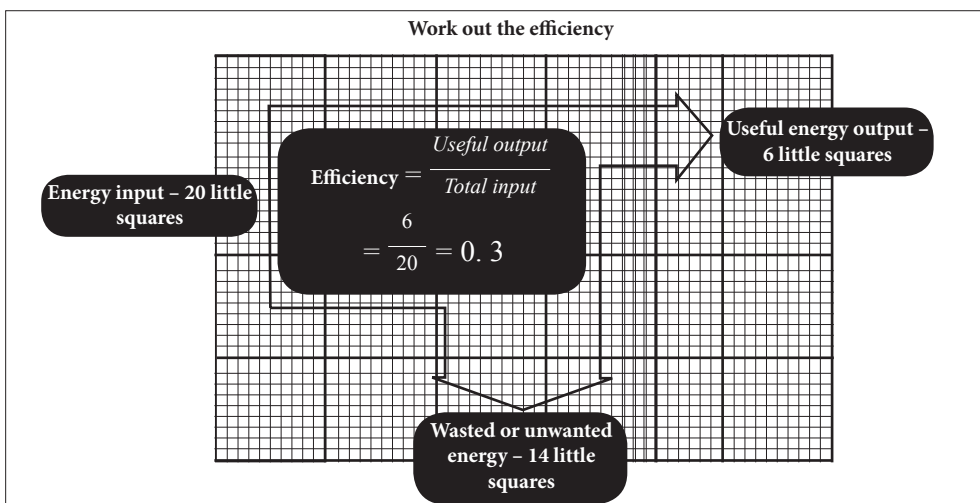
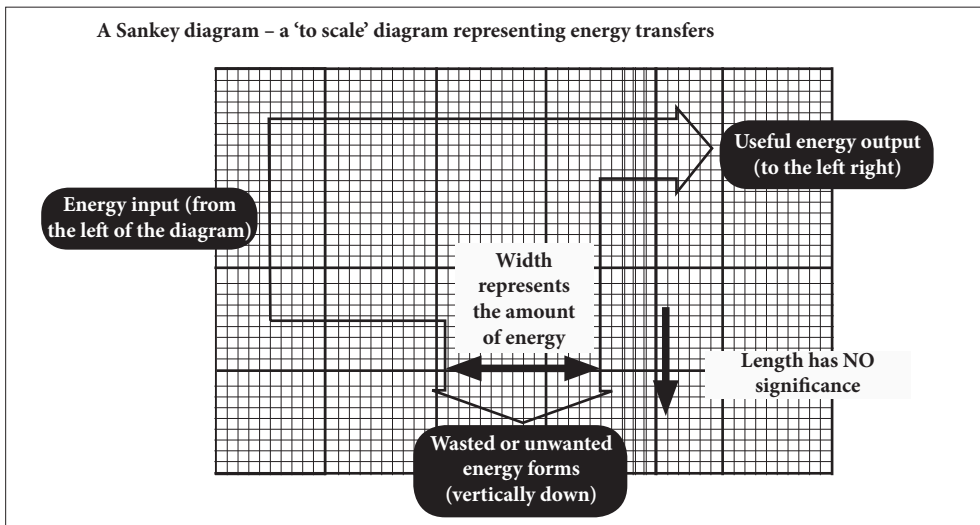

The teacher has to explain clearly diagrams. He has also to do research about it.

### **Lesson Flow**

Let the learners do the related activity in learner's book (if it is a mixed school, the number of boys and girls in each group should be balanced).

Put learners in groups (select any number of learners depending on the size of the class) make sure that they work in harmony.

Help them in selecting their group leaders.

Identify learners with special needs in group making. Encourage them to actively participate in their respective groups.

Move around the class guiding learners as they are performing the activity. In case of any assistance you can make bright learners to assist the weak ones.

Let the learners discuss their findings in their groups and finally present to the whole class.

Consolidate the lesson by developing and giving your ideas basing on learners' ideas.

### **Note**

Help the learners to work neatly and systematically.

### **Assessment criteria**

Learners may be assessed using the following methods;

- by asking them oral questions.
- making learners to work out activities.
- check and mark work of each learner.

The methods mentioned above can be varied. The use of a particular method depends on the size of the class, level of learners, availability of scholastic materials, time of the day and the moods of the learners.

## Lesson 6: Visits and field studies

---

Period 6: (80 Minutes)

- Step 1: A part of the remaining time can help you to cover what you didn't in the normal time due to various circumstances.
- Step 2: The study visit (field studies are also learning activities. Learners have to leave the school and go to the field reinforce what they learnt in class theoretically.
- Step 3: Choose the place and the activity according to the availability, the distance of the place. Also the financial standing of the class or the school.
- Step 4: The sites and activities to carry out in study visits must be related to the curriculum and on subjects in it.

### What you should remember

A field study is a general method for collecting data about users, user needs, and product requirements that involves observation and interviewing. Data are collected about *task* flows, inefficiencies, and the organizational and physical environments of users.

Investigators in field studies observe users as they work, taking notes on particular activities and often asking questions of the users. Observation may be either direct, where the investigator is actually present during the task, or indirect, where the task is viewed by some other means like a video recorder set up in an office. The method is useful early in product development to gather user requirements. It is also useful for studying currently executed tasks and processes.

### Steps in field studies

- Field studies should be carefully planned and prepared in order to ensure that the data collected is accurate, valid, and collected efficiently. The equipment needed will depend on the type of study being conducted. The process first starts with clearly stating the problem and defining the area of study. From there, a hypothesis, or a theory of explanation, is set forth to explain any occurrences expected for the specified group or phenomena. This is why, before a field study is conducted, it is important to identify the data/phenomena to observe.

- Once the hypothesis has been established, the data can be classified and scaled so that it will be easy to know how to categorise information. Observations are classified because not all field observations will be needed; therefore, the observer can know what to look for and what to disregard. Observations are also scaled to give the observer a way to rank the importance or significance of what has been observed. Once field observations are concluded, this data will be analysed and processed in order to resolve the problem initially presented or to accept or reject the hypothesis that was presented.

# UNIT 8

## Projectile and Uniform Circular Motion

Learner's book pages 279-306

**Key unit competence:** By the end of this unit, the learners should be able to analyse and solve problems related to projectile and circular motion



### Learning objectives

Learners should be able to:

- define and explain terms used in projectile and circular motion
- relate circular motion to linear motion.
- give examples of circular motion and projectile motion
- derive expressions of projectile motion

Others in the curriculum page 36

This unit is to be taught in 20 lessons, each of 40minutes

Evaluation must be done during allocated time

### Unit Breakdown

Serial number	Lesson title	Number of minutes	Periods
1	Definition of projectile motion and related terms	80	2
2	Applications of projectile motion	80	2
3	Graphs of projectile motion	80	2
4	Expressions of projectile motion	80	2
5	Definition of key terms of circular motion	80	2

Serial number	Lesson title	Number of minutes	Periods
6	Relationship between angular and linear parameters	80	2
7	Uniform circular motion	80	2
8	Distance time graph of Circular motion	80	2
9	Centripetal force	80	2
10	Applications of Circular motion	80	2

### Lesson 1: Definition of projectile motion and related terms

Period 1: (80 Minutes)

#### Introduction

Remember that learners never studied this unit in O'level. Using relevant life examples introduce the concept of projectiles and projectile motion.

Using the introduction on page 279 in learner's book, guide the learners to provide definitions to the terms:

- A projectile
- Projectile motion
- Range
- Time of flight
- Maximum Height

#### Lesson Flow

Let the learners do activity 1 page 280 in the learner's book.

Put learners in groups (select any number of learners depending on the size of the class) make sure that they work in harmony.

Help them in selecting their group leaders.

Identify learners with special needs in group making. Encourage them to actively participate in their respective groups.

Move around the class guiding learners as they are performing the activity. In case of any assistance you can make bright learners to assist the weak ones.

Let the learners discuss their findings in their groups and finally present to the whole class.

Consolidate the lesson by developing and giving your ideas basing on learners' ideas.

### **Assessment criteria**

Learners may be assessed using the following methods;

- by asking them oral questions.
- making learners to work out the activity on page 281.
- check and mark work of each learner.

The methods mentioned above can be varied. The use of a particular method depends on the size of the class, level of learners, availability of scholastic materials, time of the day and the moods of the learners.

### **Additional content**

The path taken by a projectile is called a trajectory.

The motion of a projectile is a free motion under gravity.

There are three cases: oblique projection, vertical projection and horizontal projection.

### **References**

Learner's book 4 (Physics for Rwanda Secondary Schools Book 4)

Other available Physics books in the school library.

## **Lesson 2: Applications of projectile Motion**

---

Period 2: (80 Minutes)

By use of probing and challenging questions review the previous lesson.

Guide the learners to discover the relevance and why they are studying these concepts in physics.

### **Lesson Flow**

Let the learners carry out activity 2 on page 281 in learner's book (if it is a mixed school, the number of boys and girls in each group should be balanced).

Put learners in groups (select any number of learners depending on the size of the class) make sure that they work in harmony.

Help them in selecting their group leaders.

Identify learners with special needs in group making. Encourage them to actively participate in their respective groups.

Move around the class guiding learners as they are performing the activity. In case of any assistance you can make bright learners to assist the weak ones.

Let the learners discuss their findings in their groups and finally present to the whole class.

Consolidate the lesson by developing and giving your ideas basing on learners' ideas.

Guide the learners to work through the exercises on page 292 in the learner's book.

### **Note**

While doing this exercise try to move around in case of any assistance to the learners, help them. Mark and make corrections for the work

### **Assessment criteria**

Learners may be assessed using the following methods;

- by asking them oral questions.
- making learners to work out the activities on page 281.
- check and mark work of each learner.
- giving exercises and tests.

The methods mentioned above can be varied. The use of a particular method depends on the size of the class, level of learners, availability of scholastic materials, time of the day and the moods of the learners.

For notes and more questions use learner's book.



## **References**

Learner's book 4 (Physics for Rwanda Secondary Schools Book 4)  
Other available Physics books in the school library.

## **Lesson 3: Graphs of projectile motion**

---

Period 3: (80 Minutes)

### **Introduction**

Using thought provoking and leading questions, review the previous lessons focussing especially on the trajectory of a projectile.

Using the developed knowledge of the trajectory of a projectile, guide learners to develop knowledge on how the graphs of a projectile motion are built.

### **Lesson Flow**

Let the learners do activity 3 on page 286 in learner's book (if it is a mixed school, the number of boys and girls in each group should be balanced).

Put learners in groups (select any number of learners depending on the size of the class) make sure that they work in harmony.

Help them in selecting their group leaders.

Recognise learners with special needs in group making. Let them also participate in their respective groups.

Move around the class guiding learners as they are performing the activity. In case of any assistance you can make bright learners to assist the weak ones.

Let the learners discuss their findings in their groups and finally present to the whole class.

Consolidate the lesson by developing and giving your ideas basing on learners' ideas.

As the lesson progresses, emphasise the key points as they will help learners to understand the concept.

Use the graph below to illustrate the concept of projectile motion.

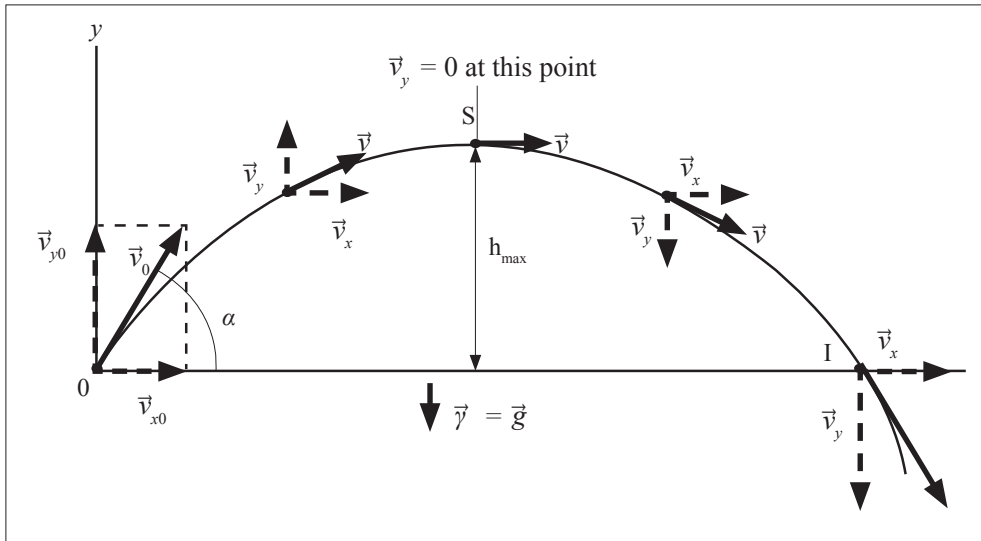

### Assessment criteria

Learners may be assessed using the following methods:

by asking them oral questions.

making learners to work out the activities.

check and mark work of each learner.

**Note** for other graphs and equations check in the learner's book 4 and other books available in the school library.

## Lesson 4: Expressions of projectile motion

Period 4: (80 Minutes)

Review the previous lesson by use of leading questions and emphasise the key points.

Using the equations of linear motion, lead the learners to discover the equations for determination of maximum height range and time of flight of the projectile.

$$\text{Expression for maximum height } y_{\max} = h_{\max} = \frac{v_0^2 \sin^2 a}{2g}$$

$$\text{Expression for time of flight. } t_f = \frac{2v_0 \sin a}{g}$$

Expression for range  $R = x_{\max} = \frac{v_0^2 \sin 2a}{g}$   $R = \frac{v_0^2 \sin 2a}{g}$

Guide the learners to develop the parametric equation for parabolic motion.

Guide the learners to discover the importance and why they are studying this concept in physics.

### Lesson Flow

Let the learners do activity 4 on page 288 in learner's book (if it is a mixed school, the number of boys and girls in each group should be balanced).

Put learners in groups (select any number of learners depending on the size of the class) make sure that they work in harmony.

Help them in selecting their group leaders.

Identify learners with special needs in group making. Encourage them to actively participate in their respective groups.

Move around the class guiding learners as they are performing the activity. In case of any assistance you can make bright learners to assist the weak ones.

Let the learners discuss their findings in their groups and finally present to the whole class.

Consolidate the lesson by developing and giving your ideas basing on learners' ideas.

## Lesson 5 and 6: Introduction to circular motion & relationship between angular & linear parameters

Period 5 and 6: (160 Minutes)

Using guided and probing questions review the previous learnt material.

Using thought provoking questions lead the learners to develop definitions of key terms in circular motion.

A motion is said to be circular if the trajectory is a circle of constant radius.

Angular displacement is the rate of change of angle

$$q = \omega_0 t$$

If a body is at rest,  $\theta_0 = 0$

Thus,  $q = \omega t$

Using the work in learner's book, try to explain clearly these equations

Let the learners participate in deriving these equations.

Guidance while teaching

Let the learners carry out work in learner's book (if it is a mixed school, the number of boys and girls in each group should be balanced).

Put learners in groups (select any number of learners depending on the size of the class) make sure that they work in harmony.

Help them in selecting their group leaders.

Identify learners with special needs in group making. Encourage them to actively participate in their respective groups.

Move around the class guiding learners as they are performing the work. In case of any assistance you can make bright learners to assist the weak ones.

Let the learners discuss their findings in their groups and finally present their reports to the whole class.

Consolidate the lesson by developing and giving your ideas basing on learners' ideas.

**Note**

Help the learners to work neatly and systematically and they should always use units (SI Units)

## **Extra content**

### **Centripetal acceleration**

As we said, in a circular uniform motion, there is acceleration.

### **Assessment criteria**

Learners may be assessed using the following methods;

- by asking them oral questions.
- making learners to work out the activities 5 and 6 on page 288 and 290.
- check and mark work of each learner.

The methods mentioned above can be varied. The use of a particular method depends on the size of the class, level of learners, availability of scholastic materials, time of the day and the moods of the learners.

## **Lesson 7 & 8: Uniform circular motion and distance time graph of Uniform circular motion**

Period 7 and 8 (160 Minutes)

By use of leading questions review the ideas used in plotting graphs of linear motion.

Using the introductory work on page 291-292 in learner's book, construct a free body diagram.

Ask the learners to mention examples of uniform circular motion in real life.

### **Lesson Flow**

Let the learners carry out work in learner's book (if it is a mixed school, the number of boys and girls in each group should be balanced).

Put learners in groups (select any number of learners depending on the size of the class) make sure that they work in harmony.

Help them in selecting their group leaders.

Identify learners with special needs in group making. Encourage them to actively participate in their respective groups.

Move around the class guiding learners as they are performing the work. In case of any assistance you can make bright learners to assist the weak ones.

Let the learners discuss their findings in their groups and finally present to the whole class.

Consolidate the lesson by developing and giving your ideas basing on learners' ideas.

### **Work to discuss during the lesson ( part of work in learner's book )**

#### **Distance time-graph of a uniform circular motion**

When an object executes a circular motion of constant radius  $R$ , its projection on an axis executes a motion of amplitude  $a$  that repeats itself back and forth, over the same path.

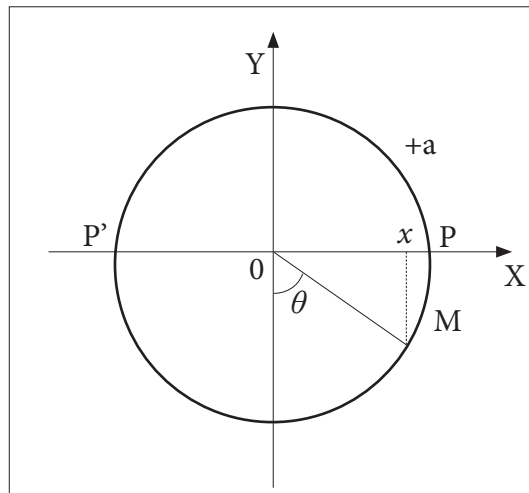

When  $M$  executes a uniform circular motion, its projection on  $X$ -axis executes a back and forth motion between positions  $P$  and  $P'$  about  $O$ .

Considering the displacement and the time, we find the following graph.

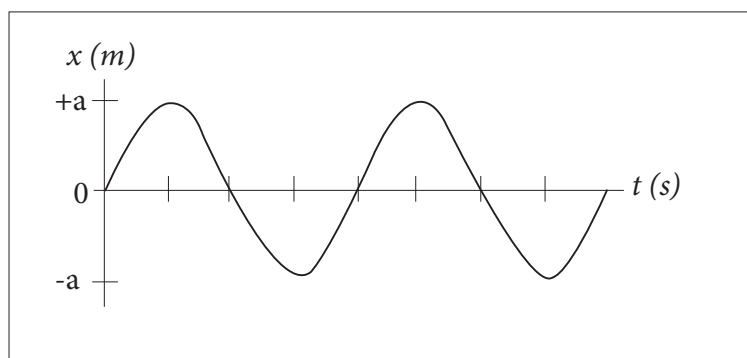

For more information (Notes and exercises check in learner's book page 292).

#### Assessment criteria

Learners may be assessed using the following methods;

- by asking them oral questions.
- making learners to work out the activities from the learner's book.
- check and mark work of each learner.

The methods mentioned above can be varied. The use of a particular method depends on the size of the class, level of learners, availability of scholastic materials, time of the day and the moods of the learners.

#### References

Learner's book 4 (Physics for Rwanda Secondary Schools Book 4)

### Lesson 9 and 10: Centripetal force & Applications of Circular motion

Period 9 and 10 (160 Minutes)

Step 1: By using probing and thought provoking questions review circular motion and centripetal force.

We expected these learners to have learnt about centripetal force.

Step 2: Through skilful questioning guide the learners to define centripetal force.

Centripetal force is the force that keeps the body to move in circular path.

Step 3: Using the introductory work on page 291 in learner's book, guide the learners to draw a free body diagram.

Step 4: Let the learners give you other examples of centripetal forces in real life.

### **Lesson Flow**

Let the learners carry out work in learner's book (if it is a mixed school, the number of boys and girls in each group should be balanced).

Put learners in groups (select any number of learners depending on the size of the class) make sure that they work in harmony.

Help them in selecting their group leaders.

Identify learners with special needs in group making. Encourage them to actively participate in their respective groups.

Move around the class guiding learners as they are performing the work. In case of any assistance you can make bright learners to assist the weak ones.

Let the learners discuss their findings in their groups and finally present to the whole class.

Consolidate the lesson by developing and giving your ideas basing on learners' ideas.

### **Assessment criteria**

Learners may be assessed using the following methods;

- by asking them oral questions.
- making learners to work out the activities on page 316.
- check and mark work of each learner.

The methods mentioned above can be varied. The use of a particular method depends on+ the size of the class, level of learners, availability of scholastic materials, time of the day and the moods of the learners.



**Additional content**

Remember that the force that is always directed towards the center is termed as centripetal force. The value of  $F$  of the centripetal force is given by Newton's second law, that is:

$F = \frac{mv^2}{R}$  Where  $m$  is the mass of the body and  $v$  is its speed in circular path of radius  $R$ . If the angular velocity of the body is  $\omega$  we can also say, since  $v = R\omega$ ,

$$F = mR\omega^2$$

When a ball is attached to a string and is swung round in horizontal circle, the centripetal force which keeps it in a circular orbit arises from the tension in the string.

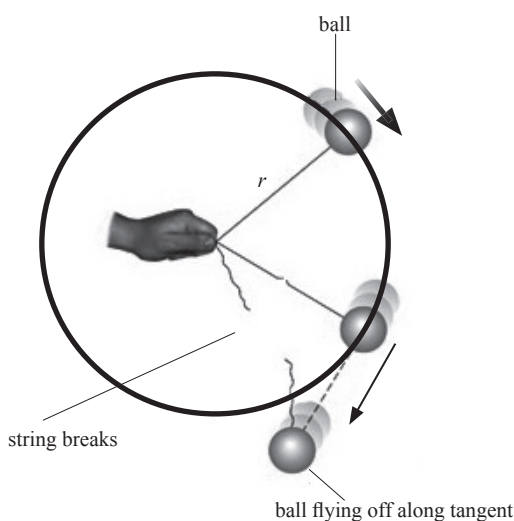

Other examples of circular motion will be discussed. In all cases it is important to appreciate that the forces acting on the body must provide a resultant force of magnitude  $\frac{mv^2}{R}$  toward the center.

You can use learner's book and other books in the library for more research or obtain information from the internet.

**References**

Learner's book 4 (Physics for Rwanda Secondary Schools Book 4).

## UNIT 9

# Universal Gravitational Field

**Learner's book pages 309-318**

**Key unit competence:** By the end of this unit, the learners should be able to explain the gravitational field potential and its applications in planet motion



### Learning objectives

Learners should be able to:

- discuss universal gravitational law.
- explain universal gravitational field.
- derive Kepler's laws of planetary motion.
- apply the law of universal gravitation and Kepler's laws to planetary motion.

Others in the curriculum page 37

This unit is to be taught in 20 lessons, each of 40 minutes

Evaluation must be done during the allocated time

### Unit Breakdown

Serial number	Lesson title	Number of minutes	Periods
1	Newton's laws of universal gravitation	80	2
2	Gravitational field	80	2
3	Universal Gravitational field potential	80	2
4	Gravitational potential	80	2
5	Relation between universal gravitational constant and force of gravity	80	4
6	Kepler's laws	80	4

Serial number	Lesson title	Number of minutes	Periods
7	Problems on gravitational potential	80	2
8	Problems on Natural and artificial satellites	80	2

### Lesson 1: Universal Gravitation field potential

Period 1: (80 Minutes)

#### Introduction

Review the law of Universal Gravitation by use of probing and leading questions.

Make sure that learners do not confuse it with newton's laws of motion

Using the introduction on page 309 in learner's book, guide the learners to develop and state Newton's law of Gravitation.

#### Lesson Flow

Let the learners do activity on page 310 in learner's book

Put learners in groups (select any number of learners depending on the size of the class) make sure that they work in harmony.

Help them in selecting their group leaders.

Identify learners with special needs in group making. Encourage them to actively participate in their respective groups.

Move around the class guiding learners as they are performing the activity. In case of any assistance you can make bright learners to assist the weak ones.

Let the learners discuss their findings in their groups and finally present to the whole class.

Consolidate the lesson by developing and giving your ideas basing on learners' ideas.

### Assessment criteria

Learners may be assessed using the following methods;

- by asking them oral questions.
- making learners to work out the activities on page 314.
- check and mark work of each learner.

The methods mentioned above can be varied. The use of a particular method depends on the size of the class, level of learners, availability of scholastic materials, time of the day and the moods of the learners.

### Additional Content/Points You Should Never Forget

The gravitational field strength  $g$  at any point in a gravitational field is the force per unit mass at that point:  $g = \frac{F}{m}$

In studying gravitation, Newton concluded that the gravitational attractive force that exists between any two masses:

- is proportional to each of the masses
- is inversely proportional to the square of their distances apart. The law states that 'The force of attraction between two masses  $m_1$  and  $m_2$  a distance  $r$  apart is directly proportional to the product of masses and inversely to the square of distance  $r$  of separation.' This force acts along the line joining the two particles. In magnitude the force is given by:  $F = G \frac{m_1 m_2}{r^2}$

For more notes consult learner's book and other available books in the school library

### References

Learner's book 4 (Physics for Rwanda Secondary Schools Book 4)

Other available Physics books in the school library.

## Lesson 2: Gravitational field

---

Period 2: (80 Minutes)

By skilfully questioning the learners review the concept of gravitation field.

Using learner's book, page 310, guide the learners to define the term gravitational field.

A field is a region of space where forces are exerted on objects with certain properties.

(Extract of learners information).

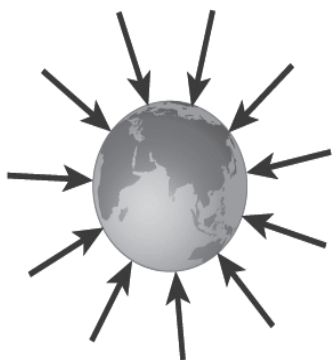

**This diagram shows that:**

- Gravitational forces are always attractive – the Earth cannot repel any objects.
- The Earth’s gravitational pull acts towards the center of the Earth.
- The Earth’s gravitational field is radial; the field lines become less concentrated with increasing distance from the Earth.

The force exerted on an object in a gravitational field depends on its position.

The less concentrated the field lines, the smaller the force. If the gravitational field strength at any point is known, then the size of the force can be calculated.

### Lesson Flow

Let the learners carry out activity 3 on page 315 in learner’s book (if it is a mixed school, the number of boys and girls in each group should be balanced).

Put learners in groups (select any number of learners depending on the size of the class) make sure that they work in harmony.

Help them in selecting their group leaders.

Identify learners with special needs in group making. Encourage them also participate in their respective groups.

Move around the class guiding learners as they are performing the activity. In case of any assistance you can make bright learners to assist the weak ones.

Let the learners discuss their findings in their groups and finally present to the whole class.

Consolidate the lesson by developing and giving your ideas basing on learners’ ideas.

Guide the learners to work through the exercises on pages 309 in the learner's book.

### **Note**

While doing this exercise, try to move around in case of any assistance to the learners Help them mark and make corrections for the work

### **Assessment Criteria**

Learners may be assessed using the following methods;

- by asking them oral questions.
- making learners to work out the activities.
- check and mark work of each learner.
- giving exercises and tests

The methods mentioned above can be varied. The use of a particular method depends on the size of the class, level of learners, availability of scholastic materials, time of the day and the moods of the learners.

For notes and more questions use learner's book.

### **References**

Learner's book 4 (Physics for Rwanda Secondary Schools Book 4)

Other available Physics books in the school library.

## **Lesson 3: Gravitational field potential**

---

Period 3: (80 Minutes)

### **Introduction**

Use challenging and thought provoking questions for reviewing the previous lesson. Build on this to introduce the concept of gravitational field potential.

Guide the learners to develop the concept of field potential and ask them to define it.

The gravitational potential at a point in a gravitational field is the potential energy per unit mass placed at that point, measured relative to infinity.

Using the way how content is arranged in learner's book, guide learners to read and interpret the information on it.

### **Lesson Flow**

Let the learners work through the examples on page 316 in learner's book (if it is a mixed school, the number of boys and girls in each group should be balanced).

Put learners in groups (select any number of learners depending on the size of the class) make sure that they work in harmony.

Help them in selecting their group leaders.

Identify learners with special needs in group making. Encourage them to actively participate in their respective groups.

Move around the class guiding learners as they are performing the activity. In case of any assistance you can make bright learners to assist the weak ones.

Let the learners discuss their findings in their groups and finally present to the whole class.

Consolidate the lesson by developing and giving your ideas basing on learners' ideas.

### **Assessment criteria**

Learners may be assessed using the following methods;

- by asking them oral questions.
- making learners to work out the activities.
- check and mark work of each learner.

**Note:** For other graphs and Equations check in the learner's book 4 and other books available in our Library.

## **Lesson 4: Gravitational potential energy**

---

Period 4: (80 Minutes)

Rewrite the previous lesson.

These learners already know potential energy  $PE=mgh$

Build on that using their suggestions to come up with the meaning of Gravitational field potential.

Remember that:

When an object is within the gravitational field of a planet, it has a negative amount of potential energy measured relative to infinity. The amount of potential energy depends on:

- the mass of the object
- the mass of the planet
- the distance between the centers of mass of the object and the planet.

The Centre of mass of a planet is normally taken to be at its Centre.

The gravitational potential energy measured relative to infinity of a mass,  $m$ , placed within the gravitational field of a spherical mass  $M$

can be calculated using:  $p. e = - \frac{GMm}{r}$

Gravitational potential,  $V$ , is given by the relationship:

$$V = - \frac{GM}{r}$$

Gravitational potential is measured in  $\text{J kg}^{-1}$ .

(Extract from learner's book 4)

Guide the learners to discuss the importance of and why they are studying this concept in physics

### Lesson Flow

Put learners in groups (select any number of learners depending on the size of the class) make sure that they work in harmony.

Help them in selecting their group leaders.

Identify learners with special needs in group making. Encourage them also participate in their respective groups.

Move around the class guiding learners as they are performing the activity. In case of any assistance you can make bright learners to assist the weak ones.



Let the learners discuss their findings in their groups and finally present to the whole class.

Consolidate the lesson by developing and giving your ideas basing on learners' ideas.

#### Assessment criteria

Learners may be assessed using the following methods;

- by asking them oral questions.
- making learners to work out the activities.

Check and mark work of each learner.

The methods mentioned above can be varied. The use of a particular method depends on the size of the class, level of learners, availability of scholastic materials, time of the day and the moods of the learners.

#### Note

For other information and equations check in the learner's book 4 and other books available in our library.

### Lesson 5: Relation between universal gravitational constant and force of gravity

Period 5: (80 Minutes)

By use of leading questions, review the previous lesson.

Considering a mass  $m$ , placed within the gravitational field of the Earth, mass  $M$ , experiences a force,  $F$ , given by:  $F = G \frac{Mm}{r^2}$

Where  $r$  is the separation of the centers of mass of the object and the Earth.

It follows from the definition of gravitational field strength as the force per unit mass that the field strength at that point,  $g$ , is related to the mass of the Earth by the expression:  $g = \frac{F}{m} = \frac{GM}{r^2}$

The same symbol,  $g$ , is used to represent: gravitational field strength  
free-fall acceleration

Let the learners participate in deriving these equations.

Let the learners carry out work in learner's book page 317 (if it is a mixed school, the number of boys and girls in each group should be balanced).

Put learners in groups (select any number of learners depending on the size of the class) make sure that they work in harmony.

Help them in selecting their group leaders.

Identify learners with special needs in group making. Encourage them to actively participate in their respective groups.

Move around the class guiding learners as they are performing the work. In case of any assistance you can make bright learners to assist the weak ones.

Let the learners discuss their findings in their groups and finally present to the whole class.

Consolidate the lesson by developing and giving your ideas basing on learners' ideas.

### **Note**

Help the learners to work neatly and systematically and remind them that they should always put units (SI Units).

### **Assessment criteria**

Learners may be assessed using the following methods;

- by asking them oral questions.
- making learners to work out the activities.
- check and mark work of each learner.

The methods mentioned above can be varied. The use of a particular method depends on the size of the class, level of learners, availability of scholastic materials, time of the day and the moods of the learners.

## **Lesson 6: Kepler's laws**

---

Period 6: (160 Minutes)

Review the concepts in circular motion and the gravitational field.

Using the introductory work on page 315 in learner's book, develop ideas and use learners suggestions that take you to Kepler's laws.

These are:

**Kepler's first law:** The path of each planet about the sun is an ellipse with the sun at one focus (or planets describe ellipse about the sun as one focus).

**Kepler's second law:** The line joining the sun to the moving planet sweeps out equal areas in equal times.

**Kepler's third law:** The squares of the times of revolution  $T$  of the planets about the sun are proportional to the cubes of their mean distances  $r$  from it:  $\frac{T^2}{r^3} = \text{constant}$

The value of this constant is  $\frac{T^2}{r^3} = \frac{4\pi^2}{GM}$ ,  $M$  is the mass of the sun in this case

### Lesson Flow

Let the learners read through page 315 in learner's book (if it is a mixed school, the number of boys and girls in each group should be balanced).

Put learners in groups (select any number of learners depending on the size of the class) make sure that they work in harmony.

Help them in selecting their group leaders.

Identify learners with special needs in group making. Encourage them to actively participate in their respective groups.

Move around the class guiding learners as they are performing the work. In case of any assistance you can make bright learners to assist the weak ones.

Let the learners discuss their findings in their groups and finally present to the whole class.

Consolidate the lesson by developing and giving your ideas basing on learners' ideas.

For more information (Notes and exercises check in learner's book pages 316 to 317).

### **Assessment criteria**

Learners may be assessed using the following methods;

- by asking them oral questions.
- making learners to work out the activities.
- check and mark work of each learner.

The methods mentioned above can be varied. The use of a particular method depends on the size of the class, level of learners, availability of scholastic materials, time of the day and the moods of the learners.

### **References**

Learner's book 4 (Physics for Rwanda Secondary Schools Book 4)

## **Lesson 7: Problems in gravitational potential**

---

Period 7: (80 Minutes)

Review the concepts in gravitational potential.

Assign them exercises related to gravitational potential.

### **Lesson Flow**

Let the learners carry out work in learner's book (if it is a mixed school, the number of boys and girls in each group should be balanced).

Put learners in groups (select any number of learners depending on the size of the class) make sure that they work in harmony.

Help them in selecting their group leaders.

Identify learners with special needs in group making. Encourage them to actively participate in their respective groups.

Move around the class guiding learners as they are performing the work. In case of any assistance you can make bright learners to assist the weak ones.

Let the learners discuss their findings in their groups and finally present to the whole class.

Consolidate the lesson by developing and giving your ideas basing on learners' ideas.

### **Assessment criteria**

Learners may be assessed using the following methods;

- by asking them oral questions.
- check and mark work of each learner.

The methods mentioned above can be varied. The use of a particular method depends on the size of the class, level of learners, availability of scholastic materials, time of the day and the moods of the learners.

You can use books in the library for more research Or obtain information from the internet.

### **References**

Learner's book 4 (Physics for Rwanda Secondary Schools Book 4)

## **Lesson 8: Problems on natural and artificial satellites**

Period 8: (80 Minutes)

Review the previous lesson.

Guide the learners to develop ideas and concepts about the motion of natural and artificial satellites.

Guide them to build short notes on the motion of both natural and artificial satellites.

### **Lesson Flow**

Let the learners carry out work in learner's book page 318 (if it is a mixed school, the number of boys and girls in each group should be balanced).

Put learners in groups (select any number of learners depending on the size of the class) make sure that they work in harmony.

Help them in selecting their group leaders.

Identify learners with special needs in group making. Encourage them to actively participate in their respective groups.

Move around the class guiding learners as they are performing the work. In case of any assistance you can make bright learners to assist the weak ones.

Let the learners discuss their findings in their groups and finally present to the whole class.

Consolidate the lesson by developing and giving your ideas basing on learners' ideas.

### **Assessment criteria**

Learners may be assessed using the following methods;

- by asking them oral questions.
- check and mark work of each learner.

The methods mentioned above can be varied. The use of a particular method depends on the size of the class, level of learners, availability of scholastic materials, time of the day and the moods of the learners.

You can use books in the library for more research or obtain information from the internet.

### **References**

Learner's book 4 (Physics for Rwanda Secondary Schools Book 4)

## UNIT 10

# Effects of Electric and Electric Potential Fields

**Learner's book pages 321-345**

**Key unit competence:** By the end of the unit, the learner should be able to analysis electric and potential fields.



### Learning objectives

---

Learners should be able to:

- recognise that an object can be charged by rubbing and there can be attraction or/and repulsion between two charged objects.
- describe the Coulomb's law for two charges being at certain distance.
- apply the Coulomb's law in resolving of problems
- solve some problems related to the Coulomb's law.
- define the electric field is.
- calculate the electric field of a point charge.
- analyse an electric field of a point charge.
- recognise the existence of field lines.
- define the field lines.
- represent field lines of isolated charges and like and unlike charges.
- recognise a uniform electric field.
- explain how a uniform electric field is created.
- calculate mathematically an electric field due to a distribution of charges.
- state the principle of superposition of electric fields.
- determine the relation between the field strength and the charge density.
- solve some problems related to electric field.

- calculate the work done by an electric force.
- explain what is the potential in the field.
- calculate the potential difference and energy of charges.
- find the relation between E and V.
- solve some problems related to electric potential
- find the equation and the trajectory of the motion of electric charges in an electric field
- mention an example of the field of applicability of the motion of charges in an electric field.
- calculate the velocity of particles when they leave an electric field.
- describe what is lightning and how it is produced.
- mention the dangers which can be caused by lightning and measures to avoid them.
- explain the importance of lightning conductor in life.
- observe and inquire about effects of electric problems; formulate hypothesis to it.
- describe functioning of lightning arrestors.

This unit is to be taught in 20 lessons, each of 40minutes

Evaluation must be done during the allocated time

### Unit Breakdown

Serial number	Lesson title	Number of minutes	Periods
1	Coulomb's law	80	2
2	Exercises	80	2
3	Electric field Notions and definitions Electric field due to a point charge	80	2
4	Field lines	80	2
5	<ul style="list-style-type: none"> <li>• Uniform field</li> <li>• Electric field due to a distribution of charges</li> <li>• Field strength and charge density</li> </ul>	80	2



<b>Serial number</b>	<b>Lesson title</b>	<b>Number of minutes</b>	<b>Periods</b>
6	<ul style="list-style-type: none"><li>• Exercises</li></ul>	80	2
7	<ul style="list-style-type: none"><li>• Potential difference</li><li>• Work of electric force</li><li>• Potential in a field</li><li>• Potential difference, work and energy of a charge</li><li>• Relation between E and V</li></ul>	80	2
8	Exercises	80	2
9	Motion of electric charge in an electric field	80	2
10	Lightning and lightning protection	80	2
	Total	800	20

### **Lesson 1: Coulomb's law**

Period 1: (80 Minutes)

- Step 1: Before you start the activity, review the electrification of objects.
- Step 2: Guide the learners to discover that there are three ways to electrify an object which are: by rubbing, by contact and by induction.
- Step 3: Let learners carry out activity 1 page 322 Step by step, let them perform the experiment and answer questions.
- Step 4: Pass through to see how the experiment is being done and suggest ways to follow in case of a problem.
- Step 5: The possible result as conclusion, there can be attraction or repulsion between two objects.
- Step 6: Assign the learners to read the information below the activity 1; learner's book page 323.
- Step 7: Instruct learners to carry out activity 2 page 323. Following the procedure. Let them write and record data. Advise the learners on the appropriate handling of materials as there are some which can be easily discharged. They must be careful also in measuring, especially lengths.

- Step 8: In the use of computer, guide learners in the filling of data in excel and how to carry out some calculations and to plot a graph with it. In the case of no access to computers it can be done manually and results will be the same.
- Step 9: When learners finish the activity, guide them to interpret the results. Draw a diagram showing two positive charges and remind learners that there can be repulsion or attraction depending on signs of charges. For the actual case, there is repulsion and show arrows expressing the repulsion and guide learners to discover that in case of attraction they change direction. The magnitude of the force acting between them when they are separated by a distance is inversely proportional to the square of the distance but also is directly proportional to the product of charges and that expresses the Coulomb's law. He'll state the law and will give the mathematical relation of it. He'll tell them that the situation can be in different mediums that can affect the magnitude of the force; reason why there is a constant  $k$  in the relation which depends on the medium and its value depends on a constant called permittivity of the medium. The way is in the learner's book on the same page. Show that the relation can take different forms depending on the permittivity. Give also some values of the relative permittivity for information and reference to learners.
- Step 10: In the case of lack of the Coulomb's apparatus, the teacher demonstrate considering the similarity with magnets and show that it respects the same law.
- Step 11: Work through the examples (exercises) applying the law to show its applicability.
- Step 12: Assign other questions to learners as homework to be done in the following lessons.

### **Lesson Flow**

Let the learners carry out the related activity in learner's book (if it is a mixed school, the number of boys and girls in each group should be balanced).

Put learners in groups (select any number of learners depending on the size of the class) make sure that they work in harmony.

Help them in selecting their group leaders.

Identify learners with special needs in group making. Encourage them to actively participate in their respective groups.

Move around the class guiding learners as they are performing the activity. In case of any assistance you can make bright learners to assist the weak ones.

Let the learners discuss their findings in their groups and finally present to the whole class.

Consolidate the lesson by developing and giving your ideas basing on learners' ideas.

### **Note**

Help the learners to work neatly and systematically.

### **Assessment criteria**

Learners may be assessed using the following methods;

- by asking them oral questions.,
- making learners to work out activities,
- check and mark work of each learner.

The methods mentioned above can be varied. The use of a particular method depends on the size of the class, level of learners, availability of scholastic materials, time of the day and the moods of the learners.

## **Lesson 2: Coulomb's law**

---

Period 2: (80 Minutes)

- Step 1: Let the learners discuss given questions in groups and guided by the teacher, and take common solution.
- Step 2: Prepare the lesson well because this is to apply what you taught. You must know also this is the time to revise and to emphasise on what learners have learned. So remind the learners on what you taught's related to the step in question.
- Step 3: You are not obliged to do all questions in the learner's book. Leave others to learners as homework.

Step 4: In preparing the lesson, choose other questions even outside the learner's book; the purpose is to raise the level of understanding of the learners. Know the level, weakness and ways to strength them.

Step 5: The procedures of solving are based on the level of learners.

### **Lesson Flow**

Let the learners do the related activity in learner's book (if it is a mixed school, the number of boys and girls in each group should be balanced).

Put learners in groups (select any number of learners depending on the size of the class) make sure that they work in harmony.

Help them in selecting their group leaders.

Identify learners with special needs in group making. Encourage them to actively participate in their respective groups.

Move around the class guiding learners as they are performing the activity. In case of any assistance you can make bright learners to assist the weak ones.

Let the learners discuss their findings in their groups and finally present to the whole class.

Consolidate the lesson by developing and giving your ideas basing on learners' ideas.

### **Note**

Help the learners to work neatly and systematically.

### **Assessment criteria**

Learners may be assessed using the following methods;

- by asking them oral questions.
- making learners to work out activities.
- check and mark work of each learner.

The methods mentioned above can be varied. The use of a particular method depends on the size of the class, level of learners, availability of scholastic materials, time of the day and the moods of the learners.

### **Lesson 3: Electric field**

Period 3: (80 Minutes)

- Notions and definitions
- Electric field due to a point charge

Step 1: Let learners respond to questions for the introduction of the lesson. Suggested answers: (a) The force acts even when charges are at a certain distance. (b) The reason is that around charges, there is a region in which charges undergo an electric force. (c) When the distance increases the force decreases.

Step 2: Guide the learners to discover that when a charge is placed in a region of the space around another charge, experiences a coulomb force. This created region by the charge is called the electric field. Bringing a charge  $q$  in a region where there is a charge  $q'$ ,  $q$  enters in a quantity  $E$  so that the force is  $F = qE$ . From that, we write  $E = F/q$ .

Step 3: Lead the learners to discover that the electric field is a vector quantity because it has a direction and a magnitude. That can also be shown considering that it's the ratio of a vector and a scalar.

Step 4: From the above relation, knowing that the force is in Newton [N] and the charge in coulomb [C] Show the unit of  $E$  which is [N/C].

Step 5: To express the electric field due to a point charge, consider the general formula of the force (Coulomb's law) and the relation  $E = F'/q$  after simplification of charges he will give the relation of  $E$ .

Step 6: For two positive charges, there is repulsion and the vector force diverges from the charge. That is also the direction of the electric field. When a negative charge is near a positive charge, there is attraction and in this case, the force changes the direction. From that observation, we have the figure 10. 5 showing directions of electric fields for the two cases of charges.

Step 7: Give examples to learners to work out but help them in correction.

#### **Lesson Flow**

Let the learners carry out the related activity in learner's book (if it is a mixed school, the number of boys and girls in each group should be balanced).

Put learners in groups (select any number of learners depending on the size of the class) make sure that they work in harmony.

Help them in selecting their group leaders.

Identify learners with special needs in group making. Encourage them to actively participate in their respective groups.

Move around the class guiding learners as they are performing the activity. In case of any assistance you can make bright learners to assist the weak ones.

Let the learners discuss their findings in their groups and finally present to the whole class.

Consolidate the lesson by developing and giving your ideas basing on learners' ideas.

### **Note**

Help the learners to work neatly and systematically.

### **Assessment criteria**

Learners may be assessed using the following methods;

- by asking them oral questions.
- making learners to work out activities.
- check and mark work of each learner.

The methods mentioned above can be varied. The use of a particular method depends on the size of the class, level of learners, availability of scholastic materials, time of the day and the moods of the learners.

## **Lesson 4: Electric field**

---

Period 4: (80 Minutes)

Field lines

Step 1: Let learners carry out activity 4 page 330 and follow the procedure up to the end and record their observations.

Step 2: Follow each step and everything done by learners in this experiment. Agree with them before each connection and start. Because working with high voltages is very risky to people so every one must be careful.

### Teaching notes

- (a) Just as scientists talk of a magnetic field in the space around a magnet, they talk of electric fields in the space around an electric charge. The grains of semolina behave like electric compass needles (electric dipoles), and line up to show the direction of the electric field.
- (b) There is an electric field spreading out from any electric charge, ready to influence any other charge and exert a force on it. This is similar to the Earth's readiness to influence mass such as the Moon, or a learner, or a mug on the edge of a table, with a gravitational force. However, the force that an electric field exerts is not there until there is a charge for the field to push or pull on. You could say 'charged' just means 'ready to make forces'.

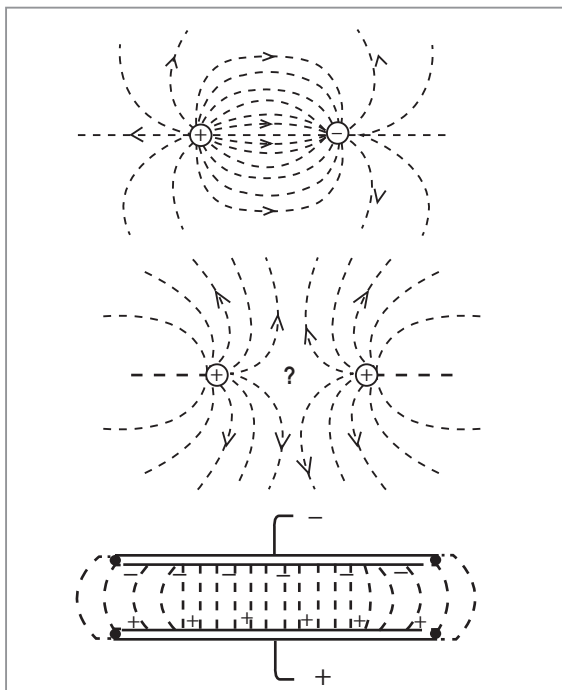

- (c) The illustrations show some electric field patterns which can be modeled in this demonstration.

Step 3: In many schools, it may be difficult to perform this activity because to realise these voltages, it's not easy for poorly equipped labs. Also to find all materials. So in this case the teacher can use magnets and iron fillings to visualise the magnetic field lines and tell learners that it is similar to electric field lines. The direction of the magnetic

field can be tested putting a compass in the field. And it can be observed that the needle of the compass takes a direction tangent to the magnetic field line.

Step 4: From that, the teacher will guide learners to define a field line and draw diagrams of field lines of isolated charges, like charges and unlike charges. This is observed considering magnets and iron fillings. The positive charge is similar to the north pole of the magnet and the negative charge is similar to the south pole of the magnet. Field lines which are on diagrams of figure 10.9 can be observed. And the direction of  $E$  can be shown by the direction of the needle of the compass in the magnetic field.

## **Lesson 5: Electric field**

---

Period 5: (80 Minutes)

- Uniform field
- Electric field due to a distribution of charges
- Field strength and charge density

Step 1: Discuss the uniform electric field from what learners have observed and recorded from the previous activity. Ask them to present what they observe when the two electrodes (or magnets) were parallel. As answer, field lines were parallel. Then the teacher guide them to discover a uniform electric field. Lead them to conclude that a field in which field lines are parallel is a uniform field. In such field the magnitude of the electric field has the same value; it doesn't depend on the distance. To create such field, we set two parallel plates which have opposite signs and which are parallel. Between the plates the field is uniform.

Step 2: In groups, learners carry out activity 5 page 333. Each group must have a sheet of paper, a pen and a ruler. The activity is to apply geometrical skills to determine the total electric field due to a distribution of charges. Let them follow the procedure up to end and discuss in groups and submit their work to. Then harmonise what they found following the procedure below.



### Mathematical relation

Let us consider various point charges  $q_1, q_2, q_3, \dots$  positive or negative having fixed positions. Let us put a point charge  $q$  at the point A.

If each point charge  $q_1, q_2, q_3, \dots$  was alone, it would exert on the charge  $q$  a force given by  $\vec{F}_1 = q\vec{E}_1, \vec{F}_2 = q\vec{E}_2, \vec{F}_3 = q\vec{E}_3$ , with  $\vec{E}_1, \vec{E}_2, \vec{E}_3$ . When the charges act together the fields that they create are stacked and the charge  $q$  is subjected to the resultant one concurrent forces:

$$\vec{F} = \vec{F}_1 + \vec{F}_2 + \vec{F}_3 + \dots = q (\vec{E}_1 + \vec{E}_2 + \vec{E}_3 + \dots)$$

$$\vec{E} = \frac{\vec{F}}{q} = \vec{E}_1 + \vec{E}_2 + \vec{E}_3 + \dots$$

**Conclusion:** The electric field created at a point of space by a system of point electric charges taking up fixed positions is equal to the geometric sum of the electric fields created in this point by each point electric charge.

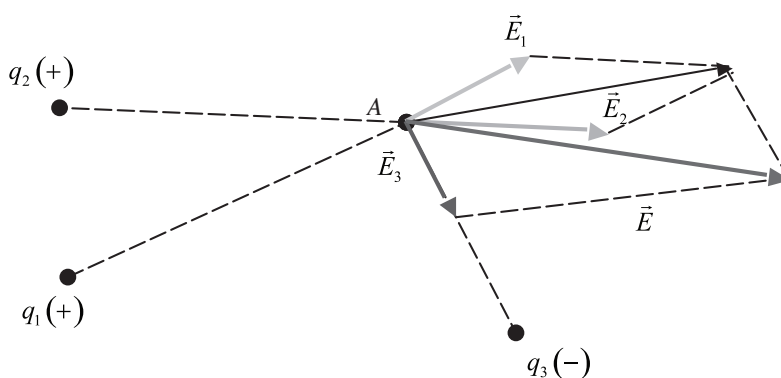

- Step 3: About the relation between the field strength and charge density, follow and explain as it's in the learner's book.
- Step 4: Work through examples in learner's book page 338 in order to apply what they've learned but the teacher will help them in the case of problem.
- Step 5: At the end, give them homework, exercises learner's book page 334 which will be corrected in the following lessons.

### **Lesson Flow**

Let the learners carry out the related activity in learner's book (if it is a mixed school, the number of boys and girls in each group should be balanced).

Put learners in groups (select any number of learners depending on the size of the class) make sure that they work in harmony.

Help them in selecting their group leaders.

Identify learners with special needs in group making. Encourage them to actively participate in their respective groups.

Move around the class guiding learners as they are performing the activity. In case of any assistance you can make bright learners to assist the weak ones.

Let the learners discuss their findings in their groups and finally present to the whole class.

Consolidate the lesson by developing and giving your ideas basing on learners' ideas.

### **Note**

Help the learners to work neatly and systematically.

### **Assessment criteria**

Learners may be assessed using the following methods;

- by asking them oral questions.,
- making learners to work out activities,
- check and mark work of each learner.

The methods mentioned above can be varied. The use of a particular method depends on the size of the class, level of learners, availability of scholastic materials, time of the day and the moods of the learners.

## **Lesson 6: Electric field**

---

Period 6: (80 Minutes)

Step 1: Set the learners to discuss given questions in groups and guide them to take the common solution.

- Step 2: Prepare the lesson carefully because this is to apply what you taught. This is the time to revise and to emphasise on what learners have learned. So he can remind the learners what he taught related to the step in question.
- Step 3: You are not obliged to work through all questions in the learner's book. Leave others to learners as homework.
- Step 4: In preparing the lesson, choose other questions even outside the learner's book; the purpose is to raise the level of understanding of learners. Know the level, their weakness how to strengthen them.
- Step 5: Remember that procedures of solving are based on the level of learners.

### **Lesson Flow**

Let the learners carry out the related activity in learner's book (if it is a mixed school, the number of boys and girls in each group should be balanced).

Put learners in groups (select any number of learners depending on the size of the class) make sure that they work in harmony.

Help them in selecting their group leaders.

Identify learners with special needs in group making. Encourage them to actively participate in their respective groups.

Move around the class guiding learners as they are performing the activity. In case of any assistance you can make bright learners to assist the weak ones.

Let the learners discuss their findings in their groups and finally present to the whole class.

Consolidate the lesson by developing and giving your ideas basing on learners' ideas.

### **Note**

Help the learners to work neatly and systematically.

### **Assessment criteria**

Learners may be assessed using the following methods;

- by asking them oral questions.,
- making learners to work out activities,
- check and mark work of each learner.

The methods mentioned above can be varied. The use of a particular method depends on the size of the class, level of learners, availability of scholastic materials, time of the day and the moods of the learners.

## Lesson 7: Potential difference

Period 7: (80 Minutes)

- Work of electric force
- Potential in a field
- Potential difference, work and energy of a charge
- Relation between E and V

Step 1: Set learners to work through activities 6, 7 and 8 page 335 and 336 because they are related to the same lesson and it can be good to do it in that way.

Step 2: Activities consist of questions whose answers will constitute notes for learners but everything had to be from learners.

Step 3: After what was from learners, conclude by developing their presentation into notes identical to the notes below.

Work of electric force

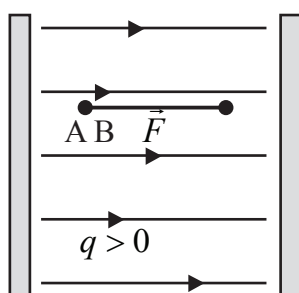

Let  $\vec{E}$  be a uniform electric field. If in this field we put an electric charge  $q$ , it will be subjected to a force given by the expression  $F = q \times E$ . If the force moves the electric charge  $q$  from A to B it accomplishes a work given by the expression:

$$W_{AB} = F \times \overline{AB} \text{ and } F = q \times E \Rightarrow W_{AB} = q \times E \times \overline{AB}$$

If  $d = \overline{AB}$ , we have  $W_{AB} = q \times E \times d$

**Remark:** The work in the uniform field does not depend on the way followed to pass to A at B but only distance separating A and B.

### Potential in a field

When an object is held at a height above the earth it is said to have gravitational potential energy. A heavy body tends to move under the force of attraction of the earth from a point of great height to one of less, and we say that points in the earth's gravitational field have potential values depending on their heights.

Electric potential is analogous to gravitational potential, but this time we think of points in an electric field. So in the field round a positive charge, for example, a positive charge moves from points near the charge to points further away. Points round the charge are said to have an "electric potential".

The electric potential at the point in the field is defined as the energy required to move unit positive charge from infinity to the point.

### Potential difference, work and energy of charges

Let us consider two points A and B in an electrostatic field of strength  $E$ , and let us suppose that the force on a positive charge  $q$  has a component  $\vec{F}$  in the direction AB. Then if we move a positively charged body from B to A, we do work against this component of the field  $\vec{E}$ .

We define the potential difference p. d between A and B as the work done in moving a unit positive charge from B to A.

Let  $V_A$  be the electric potential at the point A and  $V_B$  the electric potential at the point B. To move a positive charge from A to B, the force  $\vec{F}$  produces a work given by:

$$W_{AB} = q(V_A - V_B) = qV_{AB} \text{ with } V_A > V_B$$

$$V_A - V_B = V_{AB} = \frac{W_{AB}}{q} \text{ where } V_A - V_B = V_{AB}$$

is called potential difference.

The work done will be measured in Joules [J]. The unit of potential difference is called the volt [V] and may be defined as follows. The potential difference between two points A and B is one volt if the

work done taking one coulomb of positive charge from B to A is one Joule.

### Remarks

- Often we use the electron – volt [eV] as unit of the electric energy. The electron – volt is the energy obtained by an electron charge subject to a p. d of 1 volt.

We have:  $1[\text{eV}] = 1.6 \times 10^{-19} \text{ C} \cdot 1\text{V}$

$$= 1.6 \times 10^{-19} [\text{CV}]$$

$$= 1.6 \times 10^{-19} [\text{J}]$$

- Measurement of the potential difference is carried out with a voltmeter connected in parallel with the generator.

### Relation between E and V

The work done to move a charge  $q$  from A to B in the field is given by the expression:

$$W_{AB} = q \cdot E \cdot d$$

The same work according to the potential one at A and B is given by the expression:

$$W_{AB} = q(v_A - v_B)$$

We can write:  $q \cdot E \cdot d = q(v_A - v_B) \Rightarrow V_A - V_B = E \cdot d$

From this expression, we see that another unit of the electric field is

**Volt per metre**  $\left[ \frac{\text{V}}{\text{m}} \right]$ ; and the potential due to point charge at any

point situated at a distance  $d$  is given by:  $V = E \cdot d = k \frac{q \cdot d}{d^2} \Rightarrow$

$$V = k \frac{q}{d} = \frac{1}{4\pi\epsilon} \frac{q}{d}$$

The teacher will demonstrate examples of application to learners and they'll work through them if the time allows. If not, learners can think about them at home and before the starting of the next lesson they can do correction.

### **Lesson Flow**

Let the learners carry out the related activity in learner's book (if it is a mixed school, the number of boys and girls in each group should be balanced).

Put learners in groups (select any number of learners depending on the size of the class) make sure that they work in harmony.

Help them in selecting their group leaders.

Identify learners with special needs in group making. Encourage them to actively participate in their respective groups.

Move around the class guiding learners as they are performing the activity. In case of any assistance you can make bright learners to assist the weak ones.

Let the learners discuss their findings in their groups and finally present to the whole class.

Consolidate the lesson by developing and giving your ideas basing on learners' ideas.

### **Note**

Help the learners to work neatly and systematically.

### **Assessment criteria**

Learners may be assessed using the following methods;

- by asking them oral questions.,
- making learners to work out activities,
- check and mark work of each learner.

The methods mentioned above can be varied. The use of a particular method depends on the size of the class, level of learners, availability of scholastic materials, time of the day and the moods of the learners.

## Lesson 8: Electric potential

---

Period 8: (80 Minutes)

### Exercises

- Step 1: Set the learners to discuss given questions in groups and guide them as they come to a common solution.
- Step 2: Prepare the lesson carefully because this is to apply what he taught. This is the time to revise and to emphasise on what learners have learned. Remind the learners on what you taught related to the steps in question.
- Step 3: You are not obliged to work through all questions in the learner's book. Leave others to learners as homework.
- Step 4: In preparing the lesson, choose other questions even outside the learner's book; the purpose is to raise the level of understanding of learners. Know the level, their weakness and how to strengthen them.
- Step 5: Procedures of solving them are based on the level of learners. The teacher is the one to choose them.

### Lesson Flow

Let the learners do the related activity in learner's book (if it is a mixed school, the number of boys and girls in each group should be balanced).

Put learners in groups (select any number of learners depending on the size of the class) make sure that they work in harmony.

Help them in selecting their group leaders.

Identify learners with special needs in group making. Encourage them to actively participate in their respective groups.

Move around the class guiding learners as they are performing the activity. In case of any assistance you can make bright learners to assist the weak ones.

Let the learners discuss their findings in their groups and finally present to the whole class.



Consolidate the lesson by developing and giving your ideas basing on learners' ideas.

**Note**

Help the learners to work neatly and systematically.

**Assessment criteria**

Learners may be assessed using the following methods;

- by asking them oral questions.,
- making learners to work out activities,
- check and mark work of each learner.

The methods mentioned above can be varied. The use of a particular method depends on the size of the class, level of learners, availability of scholastic materials, time of the day and the moods of the learners.

## **Lesson 9: Motion of electric charge in an electric field**

Period 9: (80 Minutes)

- Step 1: Set learners carry out activity 10 page 339. Let them observe pictures, search in internet and establish relations. In the case of no access to Internet, they can even use book for the research. So the teacher will be careful when combining all those situations.
- Step 2: Guide the learners to respond to all questions. This is to develop work from many situations at the same time.
- Step 3: Appreciate the work of learners and guide them in the process but encourage them do everything themselves.
- Step 4: Lead them to develop notes similar to the information below in order to ensure that learners have done what they were expected to do.

Some suggested answers: (a) That is the inside of a TV set, (b) The electron gun, plates of deviation and a fluorescent screen. (c) (Learners will research), Production of electron by electron gun. This can be done in different way (to research). The produced electrons are sent in a system of plates between which an electric field exists then are sent on a screen on which we observe the arrival of electrons. (d) The upper plate is charged positively because if it was charged negatively the electric force could be acting downward

due to the direction of electric field lines. Other questions are in the information which must be given to students.

On the figure below, charges, here we consider electrons, with a horizontal vector velocity of magnitude  $V_0$  entering between two horizontal plates  $P_1$  and  $P_2$  separated by a distance  $d$ . A p. d  $V = VP_1 - VP_2$  is applied between the plates. We assume the electric field between the plates is uniform and acts on electrons on a horizontal distance  $l$  measured from 0. The point A is the point where electrons get out the electric field;  $l$  is the distance through which the uniform field acts and  $x$  the horizontal trajectory travelled by electrons. In the electric field, an electric force acts vertically on the charges. So there is deflection of electrons in the electric field.

Guide the learners to discover the trajectory of the motion in the field and some of its characteristics.

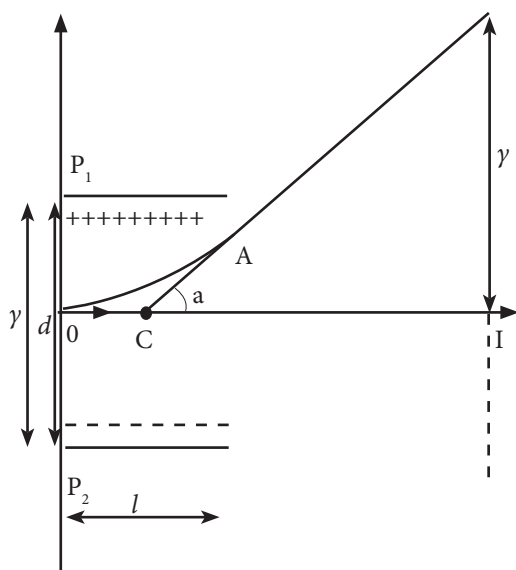

In fact:  $l = x$ , we have: 
$$\begin{cases} x = v_0 t_A & (1) \\ y = \frac{1}{2} \gamma t_A^2 & (2) \end{cases}$$

In (1)  $t_A = \frac{x}{v_0}$ ,  $F = m\gamma$  and  $F = eE$  where  $\gamma = e \frac{E}{m}$  is the acceleration of electrons. The equation of the trajectory travelled in the field is given by

$$y = \frac{1}{2} e \frac{E}{m} \frac{x^2}{v_0^2}$$

Knowing that  $E = \frac{V}{d}$ ,

$$\text{we write: } y = \frac{1}{2} e \frac{V}{dm} \frac{x^2}{v_0^2}$$

The trajectory between 0 and A is a parabola of equation:

$$y = \frac{1}{2} e \frac{E}{m} \frac{x^2}{v_0^2}$$

### Velocity in A

A being a point where electrons leave the electric field, the velocity in A is given by:

$$\vec{v}_A = \vec{v}_x + \vec{v}_y \Rightarrow v_A = \sqrt{v_x^2 + v_y^2}, v_x = v_0 \text{ and } v_y = \gamma t_A = \frac{eEl}{mv_0}$$

$$\text{The velocity in A is: } v_A = \sqrt{v_0^2 + \left( \frac{eVl}{dmv_0} \right)^2}$$

### Note:

- In establishing the formula, the teacher should remember that the motion is in the X-Y plane so each quantity has two components; according to OX and another according OY. This is the reason why we have an equation for the horizontal motion and another for the vertical motion.
- The teacher should guide the learners to discover that there are so many applications of cathode ray tubes which are a useful practical example of the motion of electrons in the electric field. He'll give some examples as TV, oscilloscope and others. Lead them to discover that oscilloscopes are used in many fields. In hospital, meteorology stations and in so many places if it's the case of studying variation of a quantity in time.

- After this lesson the teacher will assign a homework in which the learners will do research for the following lesson doing activity 11.

### **Lesson Flow**

Let the learners do the related activity in learner's book (if it is a mixed school, the number of boys and girls in each group should be balanced).

Put learners in groups (select any number of learners depending on the size of the class) make sure that they work in harmony.

Help them in selecting their group leaders.

Identify learners with special needs in group making. Encourage them to actively participate in their respective groups.

Move around the class guiding learners as they are performing the activity. In case of any assistance you can make bright learners to assist the weak ones.

Let the learners discuss their findings in their groups and finally present to the whole class.

Consolidate the lesson by developing and giving your ideas basing on learners' ideas.

### **Note**

Help the learners to work neatly and systematically.

### **Assessment criteria**

Learners may be assessed using the following methods;

- by asking them oral questions.,
- making learners to work out activities,
- check and mark work of each learner.

The methods mentioned above can be varied. The use of a particular method depends on the size of the class, level of learners, availability of scholastic materials, time of the day and the moods of the learners.

## **Lesson 10: Lightning and lightning protection**

---

Period 10: (80 Minutes)

- Step 1: Tell the learners that they have already done activity 10 as homework. So in this lesson, learners can finalise it in discussions.
- Step 2: As the explanation of the activity is in the learner's book, the research done by learners must go beyond what is in the learner's book. Ask them for example to explain how the lightning is produced. How the lightning rod works, etc.
- Step 3: Discuss the dangers of lightning to buildings and people; show how to be protected from it. Talk to learners that it's not good to be under rainfall in order to avoid that.

### **Lesson Flow**

Let the learners carry out the related activity in learner's book (if it is a mixed school, the number of boys and girls in each group should be balanced).

Put learners in groups (select any number of learners depending on the size of the class) make sure that they work in harmony.

Help them in selecting their group leaders.

Identify learners with special needs in group making. Encourage them to actively participate in their respective groups.

Move around the class guiding learners as they are performing the activity. In case of any assistance you can make bright learners to assist the weak ones.

Let the learners discuss their findings in their groups and finally present to the whole class.

Consolidate the lesson by developing and giving your ideas basing on learners' ideas.

### **Note**

Help the learners to work neatly and systematically.

**Assessment criteria**

Learners may be assessed using the following methods;

- by asking them oral questions.,
- making learners to work out activities,
- check and mark work of each learner.

The methods mentioned above can be varied. The use of a particular method depends on the size of the class, level of learners, availability of scholastic materials, time of the day and the moods of the learners.

# UNIT 11

## Applications of laws of thermodynamics

**Learner's book pages 349-379**

**Key unit competence:** By the end of this unit, the learner should be able to evaluate applications of first and second laws of thermodynamics in real life.



### Learning objectives

Learners should be able to:

- differentiate internal energy and total energy.
- explain the work done by an expanding gas.
- state the first law of thermodynamics.
- apply the first law of thermodynamics to explain the work done in isothermal, isochoric, isobaric and adiabatic processes.
- define and distinguish between principal heat capacities.
- state the second law of thermodynamics.
- explain thermodynamic processes in heat engines.
- explain the impact of heat engine on climate.

This unit is to be taught in 24 lessons, each of 40minutes.

Evaluation must be done in allocated time.

### Unit Breakdown

Serial number	Lesson title	Number of minutes	Periods
1	Internal energy and total energy (thermal energy).	40	1
2	Thermodynamic systems	40	1

Serial number	Lesson title	Number of minutes	Periods
3	Work done by an expanding gas	40	1
4	Specific heat capacities	40	1
5	First law of thermodynamics	40	1
6	Relationship between $C_p$ and $C_v$	40	1
7	Application of the first law of thermodynamics in isovolumetric process Work of electric force Potential in a field Potential difference, work and energy of a charge Relation between E and V	40	1
8	Application of thermodynamics in an isobaric process	40	1
9	An isothermal process	40	1
10	Application of thermodynamics in an isothermal process	40	1
11	Adiabatic change	40	1
12	Application of the first law of thermodynamics to derive the equations for an adiabatic change	40	1
13	Solving problems concerning the gas changes	40	1
14	Second law of thermodynamics	40	1
15	Applications of second law of thermodynamics	40	1
16	The petrol engine	40	1
17	A two stroke engine	40	1
18	Diesel engines	40	1
19	A two stroke diesel engine	40	1
20	The refrigerator	40	1



Serial number	Lesson title	Number of minutes	Periods
21	Heat engines and climate change	40	1
22-24	Exercises	120	3
	Total	800	20

### Introduction

When heat flows to or from a system, or work is done on or by a system, there is a change in the energy of this system. The study of these processes that cause these energy changes is called thermodynamics.

A thermodynamic system consists of a fixed mass of matter, often a gas, separated from its surroundings, perhaps by a cylinder or a piston. Heat engines such as petrol engine (otto engine), diesel engine, and so on contain thermodynamic systems designed to convert heat into mechanical work. Heat pumps and refrigerators are thermodynamic devices used for transferring heat from a cold body to a hotter one.

## Lesson 1: Internal energy and total energy (thermal energy)

Period 1: (40 Minutes)

Step 1: Ask learners to state what happens at boiling point if one is boiling water in a container covered with a loose cover.

From the learners' responses, explain to the learners that when this sauce pan is heated, the heat gained is used to boil off the water and extra work is done to push the sauce pan cover. This total heat energy supplied is called thermal energy.

Step 2: Put learners in groups of four and instruct them to do activity 2 page 351 in the learner's book.

Explain to the learners that when the bicycle tube is left exposed to sunshine, it gets heated and the molecules in the gas gain energy and hence its kinetic energy increases. As a result, they collide frequently with the walls of the tube and therefore exert high pressure on the walls and the tube bursts. The energy possessed by the molecules of the gas is called internal energy of the gas. This energy depends

on the temperature of the gas. When a gas is heated, its temperature increases and hence the average speed of molecules also increases increasing the internal energy of the gas. Further increase of heat supplied means that extra energy is absorbed by the molecules of the gas, hence expanding and pushing the tyre. As a result, the tyre bursts.

### **Lesson Flow**

Let the learners carry out the related activity in learner's book (if it is a mixed school, the number of boys and girls in each group should be balanced).

Put learners in groups (select any number of learners depending on the size of the class) make sure that they work in harmony.

Help them in selecting their group leaders.

Identify learners with special needs in group making. Encourage them to actively participate in their respective groups.

Move around the class guiding learners as they are performing the activity. In case of any assistance you can make bright learners to assist the weak ones.

Let the learners discuss their findings in their groups and finally present to the whole class.

Consolidate the lesson by developing and giving your ideas basing on learners' ideas.

### **Note**

Help the learners to work neatly and systematically.

### **Assessment criteria**

Learners may be assessed using the following methods;

- by asking them oral questions.
- making learners to work out activities.
- check and mark work of each learner.

The methods mentioned above can be varied. The use of a particular method depends on the size of the class, level of learners, availability of scholastic materials, time of the day and the moods of the learners.

## **Lesson 2: Thermodynamic systems**

Period 2: (40 Minutes)

Instruct learners to carry out activity 3 in the learner's book on page 352.

From the above activity, ask them to explain the term thermodynamic system. Ask the learners to describe the different types of thermodynamic systems i. e open and closed systems giving examples for each case.

Step 2: Instruct learners to carry out activity 4 in learner's book page 353.

Remind the learners that heat is the energy that flows by conduction, convection or radiation from one body to another because of a temperature difference between them. These bodies where exchange of heat to other forms of energy occurs are called thermodynamic systems.

A thermodynamic system consists of a fixed mass of matter, often a gas, separated from its surroundings, perhaps by a cylinder and a piston. For example, Heat engines such as a petrol engine, a steam turbine and jet engine all contain thermodynamic systems designed to convert heat into mechanical work. Heat pumps and refrigerators are thermodynamic devices for transferring heat from a cold body to a hotter one.

In such devices, energy is transferred from one system to another by a force moving its point of application in its own direction.

The energy of a system, whether transferred to it as heat or work is termed as the internal energy of the system.

When there is no heat transfer between two systems, that is, the two are at the same temperature, they are said to be in thermal equilibrium.

### **Lesson Flow**

Let the learners carry out the related activity in learner's book (if it is a mixed school, the number of boys and girls in each group should be balanced).

Put learners in groups (select any number of learners depending on the size of the class) make sure that they work in harmony.

Help them in selecting their group leaders.

Identify learners with special needs in group making. Encourage them to actively participate in their respective groups.

Move around the class guiding learners as they are performing the activity. In case of any assistance you can make bright learners to assist the weak ones.

Let the learners discuss their findings in their groups and finally present to the whole class.

Consolidate the lesson by developing and giving your ideas basing on learners' ideas.

### **Note**

Help the learners to work neatly and systematically.

### **Assessment criteria**

Learners may be assessed using the following methods;

- by asking them oral questions.
- making learners to work out activities.
- check and mark work of each learner.

The methods mentioned above can be varied. The use of a particular method depends on the size of the class, level of learners, availability of scholastic materials, time of the day and the moods of the learners.

## **Lesson 3: Work done by an expanding gas**

---

Period 3: (40 Minutes)

Step 1: Ask learners to explain why a bicycle pump gets hot when one pumps air into it.

Step 2: If possible, look around your school and let the learners fill a bicycle pump and feel what happens.

Step 3: Use leading questions to guide the learners to discover that **when you compress air in a bicycle pump**, your muscles transfer energy to the handle, which in turn transfers energy to the molecules of air in the pump. This additional energy makes the molecules move faster. As they are compressed into a smaller space, they also collide

more often with the wall of the pump, so they transfer more energy to the metal wall and it becomes hot.

Step 4: Guide the learners to derive the work done by the expanding gas.

Use a syringe to show the change in volume when the gas expands.

#### **Lesson 4: Specific heat capacities**

---

Period 4: (40 Minutes)

Step 1: Instruct the learners to carry out activity 7 page 359 in the learner's book.

Step 2: Guide to the learners to discover that, gases are considered to have a number of specific heat capacities. A change in temperature of a gas is likely to cause large changes in pressure and volume of the gas but for solids or liquids, the change in pressure is neglected since they are almost not affected by pressure.

In solids and liquids, heat energy is calculated by measuring the mass of the liquids and solids. However in gases, we replace the mass with the number of moles of a gas.

When the specific heat capacity of a gas is measured in terms of its moles, it is known as principal specific heat capacity. There are two important heat capacities: the molar heat capacity and constant volume ( $C_v$ ) and molar heat capacity at constant pressure ( $C_p$ ).

The principal molar heat capacity at constant volume ( $C_v$ ) is defined as the heat required to increase the temperature of one mole of a gas at constant volume by one Kelvin.

The principal molar heat capacity at constant pressure ( $C_p$ ) is the amount of heat required to increase the temperature of one mole of a gas at constant pressure by one Kelvin.

The molar heat capacities have units  $\text{Jmol}^{-1}\text{K}^{-1}$ .

Since at constant volume, the work done by a gas is zero, from  $W = P\Delta V$ , ( $\Delta V = 0$ ), then it is evident that the principal K molar heat capacity at constant pressure,  $C_p$  is greater than that at constant volume,  $C_v$ . The heat supplied at constant pressure is used to increase internal energy plus the work done in the expansion of the gas.

### **Lesson Flow**

Let the learners carry out the related activity in learner's book (if it is a mixed school, the number of boys and girls in each group should be balanced).

Put learners in groups (select any number of learners depending on the size of the class) make sure that they work in harmony.

Help them in selecting their group leaders.

Identify learners with special needs in group making. Encourage them to actively participate in their respective groups.

Move around the class guiding learners as they are performing the activity. In case of any assistance you can make bright learners to assist the weak ones.

Let the learners discuss their findings in their groups and finally present to the whole class.

Consolidate the lesson by developing and giving your ideas basing on learners' ideas.

### **Note**

Help the learners to work neatly and systematically.

### **Assessment criteria**

Learners may be assessed using the following methods;

- by asking them oral questions.
- making learners to work out activities.
- check and mark work of each learner.

The methods mentioned above can be varied. The use of a particular method depends on the size of the class, level of learners, availability of scholastic materials, time of the day and the moods of the learners.

## **Lesson 5: First law of thermodynamics**

---

Period 5: (40 Minutes)

Step 1: Ask learners to recall what they observed in the previous activity. Ask them to explain why heat supplied at constant pressure is higher than that at constant volume.

Step 2: Lead the learners to conclude that when a quantity of heat  $\Delta Q$  is supplied to a gas, two things happen:

- (i) the heat supplied may increase the internal energy,  $U$ , of the gas and the gas may expand and do some work,  $W$  in moving the piston.

Statement of the law of thermodynamics: The amount of heat supplied is equal to the change in internal energy of the gas plus the work done by the gas.

i. e  $\Delta Q = \Delta U + \Delta W$

- (ii) The magnitude of internal energy depends on the temperature of the gas i. e the internal energy is high at a high temperature and low at low temperature.

Step 3: since  $\Delta W = P\Delta V$ ,

It follows that  $\Delta Q = \Delta U + P\Delta V$

When  $n$  moles of a gas are considered, the amount of heat supplied at constant pressure is  $nC_p\Delta T$ , whereas the amount of heat supplied at constant volume would be  $nC_v\Delta T$ .

**Lesson 6: Relationship between  $C_p$  and  $C_v$**

Period 6: (40 Minutes)

Step 1: Ask learners to state the first law of thermodynamics.

With the help of the law of thermodynamics, guide the learners to derive the relation,  $C_p - C_v = R$

From the first law of thermodynamic, at constant volume,

$$\Delta Q = \Delta U + \Delta W$$

$$\Delta Q = \Delta U = 1 \times C_v \times \Delta T$$

It therefore follows that  $\Delta U = C_v\Delta T$  ..... (i)

At constant pressure,  $\Delta Q = \Delta U + \Delta W$

In this case,  $\Delta U = C_v\Delta T$ ;  $\Delta W = P\Delta V$

And  $\Delta Q = C_p\Delta T$

From equation (i)

$$\Delta Q = \Delta U + \Delta W, \dots\dots\dots(ii)$$

$$\text{It follows that } C_p \Delta T = C_v \Delta T + P \Delta V \dots\dots\dots (iii)$$

Step 2: Ask learners to state the ideal gas equation.

From the ideal gas equation,  $PV = RT$ .

If the volume of the gas changes by  $\Delta V$  and the temperature by  $\Delta T$ ;

$$P(V + \Delta V) = R(T + \Delta T).$$

$$PV + P\Delta V = RT + T\Delta T$$

$$= P\Delta V = R\Delta T \dots\dots\dots(iv)$$

Substituting (iv) in (iii)

$$C_p = C_v \Delta T + R\Delta T$$

$$C_p \Delta T = (C_v + R) \Delta T$$

$$C_p = C_v + R$$

Therefore  $(C_p - C_v) = R$

Where  $R$  is the universal molar gas constant whose value is  $8.31 \text{ Jmol}^{-1}\text{K}^{-1}$

### Lesson Flow

Let the learners carry out the related activity in learner's book (if it is a mixed school, the number of boys and girls in each group should be balanced).

Put learners in groups (select any number of learners depending on the size of the class) make sure that they work in harmony.

Help them in selecting their group leaders.

Identify learners with special needs in group making. Encourage them to actively participate in their respective groups.

Move around the class guiding learners as they are performing the activity. In case of any assistance you can make bright learners to assist the weak ones.



Let the learners discuss their findings in their groups and finally present to the whole class.

Consolidate the lesson by developing and giving your ideas basing on learners' ideas.

### **Note**

Help the learners to work neatly and systematically.

### **Assessment criteria**

Learners may be assessed using the following methods;

- by asking them oral questions.
- making learners to work out activities.
- check and mark work of each learner.

The methods mentioned above can be varied. The use of a particular method depends on the size of the class, level of learners, availability of scholastic materials, time of the day and the moods of the learners.

### **References**

Learner's book 4 (Physics for Rwanda Secondary Schools Book 4)

Other available Physics books in the school Library.

## **Lesson 7: Application of the first law of thermodynamics in is - ovolumetric process**

Period 7: (40 Minutes)

Step 1: Let the learners carry out activity 8 on page 360 in learner's book.

When the pressure in a system changes but the volume is constant, you have what is called an isochoric process. An example of this would be a simple closed container, which can't change its volume as seen in the activity 8.

An isovolumetric or isochoric change is the one that occurs at constant volume. It means that the pressure and temperature of the gas are changing at constant volume.

Step 2: Lead the learners to conclude that in this case, the volume is constant, and from the law of thermodynamics, no work is done by the gas since  $\Delta V = 0$ .

Step 3: Guide the learners to derive the expression for work done in an isovolumetric( isochoric) process.

This process takes place at constant volume and since

$$\Delta V = 0, \Delta W = \int P \Delta V = 0$$

$$\Delta Q = \Delta U$$

$$= C_v \Delta T$$

Hence, in this process, the energy supplied is used to increase the internal energy since the internal energy is independent of the volume.

### **Lesson Flow**

Let the learners carry out the related activity in learner's book (if it is a mixed school, the number of boys and girls in each group should be balanced).

Put learners in groups (select any number of learners depending on the size of the class) make sure that they work in harmony.

Help them in selecting their group leaders.

Identify learners with special needs in group making. Encourage them to actively participate in their respective groups.

Move around the class guiding learners as they are performing the activity. In case of any assistance you can make bright learners to assist the weak ones.

Let the learners discuss their findings in their groups and finally present to the whole class.

Consolidate the lesson by developing and giving your ideas basing on learners' ideas.

### **Note**

Help the learners to work neatly and systematically.

### **Assessment criteria**

Learners may be assessed using the following methods;

- by asking them oral questions.

- making learners to work out activities.
- check and mark work of each learner.

The methods mentioned above can be varied. The use of a particular method depends on the size of the class, level of learners, availability of scholastic materials, time of the day and the moods of the learners.

### **References**

Learner's book 4 (Physics for Rwanda Secondary Schools Book 4)

Other available Physics books in the school Library.

## **Lesson 8: Application of thermodynamics in an isobaric process**

Period 8: (40 Minutes)

- Step 1: Put the learners in groups of four.
- Step 2: Let each group choose a leader and they discuss activity 9 in the learner's book on page 360. Let each group present their views.
- Step 3: Consolidate their responses by explaining to them that heating substances in open containers imply that the pressure of the substance is kept constant. This process is called an isobaric process. An isobaric process is the one that occurs at constant pressure.

Heating of water in an open vessel and the expansion of a gas in a cylinder with a freely moving piston are typical examples of isobaric processes. In both cases, the pressure is equal to atmospheric pressure. For example, when a liquid is being heated, its volume increases and the pressure inside the container is constant since the number of collisions between water molecules and the walls of the container is constant.

The same process occurs when a gas enclosed in a cylinder with a frictionless piston is heated such that at any time, the gas pressure equals the external pressure.

- Step 4: Work done by the gas in the isobaric process

Guide the learners to derive an expression for the work done by the gas in the isobaric process using the first law of thermodynamics.

From the law of thermodynamics,  $\Delta Q = \Delta U + \Delta W$

In this case the external heat supplied is equal to the increase in internal energy,  $CV$  of the gas plus the work done by the gas.

$$\Delta Q = CV\Delta T + \Delta W$$

When the gas expands from volume  $V_1$  to  $V_2$ ,

$$P\Delta V = P(V_2 - V_1)$$

It follows that  $\Delta Q = CV\Delta T + P(V_2 - V_1)$ .

### **Lesson Flow**

Let the learners carry out the related activity in learner's book (if it is a mixed school, the number of boys and girls in each group should be balanced).

Put learners in groups (select any number of learners depending on the size of the class) make sure that they work in harmony.

Help them in selecting their group leaders.

Identify learners with special needs in group making. Encourage them to actively participate in their respective groups.

Move around the class guiding learners as they are performing the activity. In case of any assistance you can make bright learners to assist the weak ones.

Let the learners discuss their findings in their groups and finally present to the whole class.

Consolidate the lesson by developing and giving your ideas basing on learners' ideas.

### **Note**

Help the learners to work neatly and systematically.

### **Assessment criteria**

Learners may be assessed using the following methods;

- by asking them oral questions.
- making learners to work out activities.
- check and mark work of each learner.

The methods mentioned above can be varied. The use of a particular method depends on the size of the class, level of learners, availability of scholastic materials, time of the day and the moods of the learners.

### **References**

Learner's book 4 (Physics for Rwanda Secondary Schools Book 4)

Other available Physics books in the school Library.

## **Lesson 9: An isothermal process**

---

Period 9: (40 Minutes)

Step 1: Divide the learners in groups of four and provide each group with a polythene bag and an ice-water mixture.

Step 2: Instruct the learner to carry out activity 10 in the learner's book on page 362.

Step 3: Let each group present their findings.

Possible responses: The gas condenses into water and the water formed settles at the bottom of the polythene bag.

The temperature on the thermometer remains constant.

Step 4: This change is called Condensation. It takes place at constant temperature and is thus an example of an isothermal process.

In an isothermal process, volume of a gas changes with pressure at constant volume. An isothermal change can be reversible. It is either a compression or expansion of a gas at a constant temperature.

Step 5: Conditions necessary for an isothermal process to occur

Let the learners carry out activity 11 on page 363 in the learner's book.

For an isothermal process to take place, the gas must be contained in a thin-walled heat conducting vessel/container in good thermal contact with a constant temperature reservoir.

The process must be carried out slowly to allow time for heat exchange to take place.

## Lesson 10: Application of thermodynamics in an isothermal process

Period 10: (40 Minutes)

Step 1: Work done by a gas in an isothermal change.

Ask learners if they have ever tried to boil water in a closed sauce pan.

Ask them what happens to the cover when the vapour starts to come off the water.

Possible response: The vapour pushes the cover off the pan.

Step 2: Guide the learners to conclude that the vapour does work on the cover since it acts on it and pushes it upwards.

Step 3: Guide the learners to derive the expression for the work done by the gas in an isothermal process.

From the first law of thermodynamics,  $\Delta Q = \Delta U + \Delta W$ .

When the volume of gas changes by  $\Delta V$  at constant temperature then the pressure has also to change so that the ideal gas equation is satisfied.

The work done,  $W$  is then given by

$$W = \int Pdv$$

But  $PV = RT$  (For 1 mole of gas)

It follows that  $P = \frac{RT}{V}$

$$W = \int \frac{RT}{V} dv$$

Thus,  $W = RT \int \frac{dv}{v}$

$$= RT \ln[V]$$

$$W = W = RT$$

$$= RT \ln \frac{V_2}{V_1}$$

From the above equation, the following can be drawn;

(i) When the gas expands (i. e  $V_2 > V_1$ ), then  $W$  is positive.

- (ii) When the gas is compressed (i. e.  $V_2 < V_1$ ), thus  $W$  is positive, meaning that work is done on the gas in compressing it.

### **Lesson 11: Adiabatic change**

---

Period 11: (40 Minutes)

- Step 1: Look for a bicycle pump and a tube, divide the learners into groups of five.
- Step 2: Let the learners pump the tube and leave the inflated tube standing for five to ten minutes.
- Step 3: Let the learners open the tube slowly while placing their other hand in the path of the air coming out of the tube. Ask the learners what they have noticed.

Possible response: The air coming out of the tyre is warm.

- Step 4: Ask the learners to explain why the air coming out of the tube is warmer than the surrounding air.

As one pumps, the air molecules are compressed into a smaller space, they thus collide more often and so they transfer more energy to one another and become hot. No heat has been supplied to the system. It is called an adiabatic compression.

- Step 4: Let the learners pump the tyre again.

Let them leave it standing and go back to class but make sure that the tyre is not exposed to sunshine.

Instruct the learners to open the tyre after two hours after the lesson and note the temperature of the air coming out of the tube. Lead them to discover that the air coming out will be cold compared to the surrounding air.

Guide the learners to conclude that heat has been lost but not to the surroundings by the air but when the air is left standing, expansion occurs. This is associated with a decrease in temperature. It is called an adiabatic expansion.

- Step 5: Application of first law of thermodynamics to derive the expression for the work done by the gas in an adiabatic change.

An adiabatic change is process in which no heat enters or leaves the gas system. It is either an expansion or a compression.

Since  $\Delta Q = \Delta U + P\Delta V$  and  $\Delta Q = 0$

$$0 = C_v \Delta T + P\Delta V$$

$$\text{Or } \Delta U = -P\Delta V$$

If the gas expands, it does work, its internal energy is reduced and hence the temperature is lowered.

If the gas is compressed, work is done on the gas, its internal energy will increase and therefore its temperature rises.

Step 6: P-V diagram for an adiabatic change.

Guide the learners to draw a pressure – volume diagram for an adiabatic change.

Step 7: Conditions that is necessary for an adiabatic change to occur

Ask learners how they always protect themselves from a bad weather.

Possible response: By wearing jackets and sweaters.

On a cold day, we always wear woolen jackets to protect ourselves from coldness. Therefore no heat is either lost to the surrounding and or gained. In this case, an adiabatic process is achieved.

Therefore, for an adiabatic process to be achieved, the gas must be contained in a thick –walled and perfectly insulated isolated container, and the process must be carried out rapidly to avoid any possible heat exchanges between the gas system and the surroundings.

### **Lesson Flow**

Let the learners carry out the related activity in learner's book (if it is a mixed school, the number of boys and girls in each group should be balanced).

Put learners in groups (select any number of learners depending on the size of the class) make sure that they work in harmony.

Help them in selecting their group leaders.



Identify learners with special needs in group making. Encourage them to actively participate in their respective groups.

Move around the class guiding learners as they are performing the activity. In case of any assistance you can make bright learners to assist the weak ones.

Let the learners discuss their findings in their groups and finally present to the whole class.

Consolidate the lesson by developing and giving your ideas basing on learners' ideas.

### **Note**

Help the learners to work neatly and systematically.

### **Assessment criteria**

Learners may be assessed using the following methods;

- by asking them oral questions.
- making learners to work out activities.
- check and mark work of each learner.

The methods mentioned above can be varied. The use of a particular method depends on the size of the class, level of learners, availability of scholastic materials, time of the day and the moods of the learners.

### **References**

Learner's book 4 (Physics for Rwanda Secondary Schools Book 4)  
Other available Physics books in the school Library.

## **Lesson 12: Application of the first law of thermodynamics to derive the equations for an adiabatic change**

Period 12: (40 Minutes)

Step 1: Ask learners to state the law of thermodynamics.

Response: It states that,

$$\Delta Q = \Delta U + P\Delta V$$

Step 2: Relationship between pressure and volume.

Guide the learners to derive the relation  $pV^\gamma = \text{a constant}$

From the first law of thermodynamics,  $\Delta Q = \Delta U + P\Delta V$

For an adiabatic process,  $\Delta Q = 0$ , and for 1 mole of a gas,

$$\Delta U = C_v \Delta T$$

$$C_v \Delta T = 0$$

For infinite small changes,

$$C_v dT + PdV = 0 \dots\dots\dots (i)$$

But from the ideal gas equation, for one mole,  $PV = RT$ , so,

$$P = \frac{RT}{V} \dots\dots\dots (ii)$$

Substitute (ii) in (i)

$$C_v dT + dv = 0$$

Dividing throughout by T;

$$C_v + R = 0 \dots\dots\dots (iii)$$

But  $C_p - C_v = R$ ;

$$C_v + (C_p - C_v) = 0$$

Dividing throughout by  $C_v$ ;

$$\begin{aligned} \text{Let } \gamma &= (\text{the ratio of the principal heat capacities}) \\ &= (1 - \gamma) \end{aligned}$$

$$\text{It follows that, } = (1 - \gamma) \dots\dots\dots (iv)$$

Integrating both sides for (iv)

$$\int = \int (1 - \gamma)$$

$$\text{Log}_e T = (1 - \gamma) \text{log}_e V + \text{log}_e A; A = \text{a constant}$$

$$\text{Log}_e T = \text{Log}_e + \text{log}_e A$$

$$\text{It follows that } \text{Log}_e T = \text{log}_e AV^{(1-\gamma)}$$

$$T = AV^{1-\gamma}$$

$$\text{Hence } TV^{\gamma-1} = \text{a constant} \dots\dots (v)$$

$$\text{From } PV = RT, T = \dots\dots\dots (vi)$$

Substitute (vi) in (v)

$$\frac{PV}{R} \times V^{\gamma-1} = \text{a constant}$$

Therefore,  $PV^\gamma = \text{a constant}$

Step 3: Instruct learners to derive the relation between pressure and temperature;

$$T^\gamma P^{1-\gamma} = \text{a constant}$$

### **Lesson Flow**

Let the learners carry out the related activity in learner's book (if it is a mixed school, the number of boys and girls should be balanced).

Put learners in groups (select any number of learners depending on the size of the class) make sure that they work in harmony.

Help them in selecting their group leaders.

Identify learners with special needs in group making. Encourage them to actively participate in their respective groups.

Move around the class guiding learners as they are performing the activity. In case of any assistance you can make bright learners to assist the weak ones.

Let the learners discuss their findings in their groups and finally present to the whole class.

Consolidate the lesson by developing and giving your ideas basing on learners' ideas.

### **Note**

Help the learners to work neatly and systematically.

### **Assessment criteria**

Learners may be assessed using the following methods;

- by asking them oral questions.
- making learners to work out activities.
- check and mark work of each learner.

The methods mentioned above can be varied. The use of a particular method depends on the size of the class, level of learners, availability of scholastic materials, time of the day and the moods of the learners.

### **References**

Learner's book 4 (Physics for Rwanda Secondary Schools Book 4)

Other available Physics books in the school library.

### Lesson 13: Solving problems concerning the gas changes

---

Period 13: (40 Minutes)

Step 1: Work through the example on page 367 in the learner's book.

A gas has a volume of  $0.02\text{m}^3$  at a pressure of  $2 \times 10^5\text{Pa}$  and a temperature  $27^\circ\text{C}$ . It is heated at constant pressure until its volume increases to  $0.03\text{m}^3$ . Calculate the:

- (i) External work done.
- (ii) New temperature of the gas.
- (iii) Increase in internal energy of the gas if its mass is 16g, its molar heat capacity at constant volume is  $0.8\text{Jmol}^{-1}\text{K}^{-1}$  and the molar mass is 32gm.

Step 2: Write the equation of the example on page 368 in the learner's book and call a learner to do it from the chalk board.

Step 3: Correct the learner's work by talking about key points to consider while attempting such questions.

Step 4: Instruct learners to attempt number 3 of the exercise on page 368-369 in the learner's book.

### Lesson 14: Second law of thermodynamics

---

Period 14: (40 Minutes)

Step 1: Ask learners if they know of some devices that use liquids or gases to operate.

Possible response: Engines, domestic hot water supply, refrigerators

Step 2: Ask the learners how liquids or gases are used in each device.

Possible responses: The engines consume fuels for example petrol and diesel to operate. In the domestic hot water supply, when hot water is ran from the lower tap, cold water enters the system from the reservoir tank.

Step 3: Statement of second law of thermodynamics

Explain to the learners that some devices like those mentioned above use fluids which move with in the device in different cycles.

For example, “no heat engine can perform a cyclic operation whose only result is to convert internal energy into mechanical energy” This is the statement of first law of thermodynamics

The second law of thermodynamics can also be stated as “no refrigerator (or heat pump) can transfer internal energy from a cold reservoir to a hot reservoir without some external agent doing work.”

## **Lesson 15: Applications of second law of thermodynamics**

Period 15: (40 Minutes)

### Step 1: Heat engines

Ask learners if they have ever heard of engines.

Ask them where the engines are exactly used and how they operate.

Lead them to conclude that any device which will convert heat cyclically into mechanical work is called a heat engine. It is a machine, which changes heat energy, obtained by burning a fuel, to kinetic energy.

The material which, on being supplied with heat, performs mechanical work is called the working substance.

The working substance of engines in motor vehicles are liquid petrol and diesel.

### Step 2: Carnot cycle.

Ask the learners how the petrol and diesel are used in an engine.

The cycle of operations through which the working substance has been taken is called carnot’s cycle. The heat is absorbed taken in at one constant temperature and all the heat rejected to the sink is given out at another constant temperature. No work is done at any stage in overcoming frictions, and no heat is lost to the surrounding, and the cycle is completely reversible.

A carnot cycle is called an ideal heat engine because in all practical engines, work is done in overcoming friction and heat is lost to the surroundings.

**Step 3: Otto cycle and diesel engine.**

Guide the learners and explain the two types of cycles. An Otto cycle is an idealised thermodynamic cycle which describes the functioning of a typical spark ignition reciprocating piston engine, the thermodynamic cycle most commonly found in automobile engine.

The Otto cycle consists of adiabatic compression, heat addition at constant volume, adiabatic expansion, and rejection of heat at constant volume.

The Diesel cycle is the thermodynamic cycle, which approximates the pressure and volume of the combustion chamber of the Diesel engine.

**Lesson Flow**

Let the learners do the related activity in learner's book (if it is a mixed school, the number of boys and girls in each group should be balanced).

Put learners in groups (select any number of learners depending on the size of the class) make sure that they work in harmony.

Help them in selecting their group leaders.

Identify learners with special needs in group making. Encourage them to actively participate in their respective groups.

Move around the class guiding learners as they are performing the activity. In case of any assistance you can make bright learners to assist the weak ones.

Let the learners discuss their findings in their groups and finally present to the whole class.

Consolidate the lesson by developing and giving your ideas basing on learners' ideas.

**Note**

Help the learners to work neatly and systematically.

### **Assessment criteria**

Learners may be assessed using the following methods;

- by asking them oral questions.
- making learners to work out activities.
- check and mark work of each learner.

The methods mentioned above can be varied. The use of a particular method depends on the size of the class, level of learners, availability of scholastic materials, time of the day and the moods of the learners.

### **References**

Learner's book 4 (Physics for Rwanda Secondary Schools Book 4)

Other available Physics books in the school Library.

## **Lesson 16: The petrol engine**

---

Period 16: (40 Minutes)

Step 1: Let the learners carry out activity 18 In the learner's book on page 374.

Explain to the learners that many vehicles use petrol in order to move. Such vehicles are small cars and motorcycles. The engine they have is called a petrol engine since it uses petrol to operate. It operates by moving the piston. The upward and downward movement of the piston is called a stroke. There are two types of petrol engines; a four stroke engine and a two stroke engine. In petrol engines, Petrol is mixed with air and exploded inside the engine cylinder. The explosion is used to force down a closely fitting piston.

Step 2: Four stroke engine:

This is the common type of petrol engine. It is called a four stroke engine because there is only one power strike in four strokes. The other strokes suck petrol and air in, compress the mixture and push the burnt gas out.

Step 3: The strokes of a petrol engine: Discuss with the learners the sequence of the four strokes of the engine.

- (i) Intake stroke: In this, inlet valve opens, air and petrol mixture enter the cylinder, and the piston goes down as the exhaust valve closes decreasing the pressure within.
- (ii) Compression: Both valves are shut, the piston moves up compressing the petrol and air.
- (iii) Power stroke: Both valves are still shut, spark plug produces a spark which ignites the mixture, the piston moves down and power is obtained plus some energy (chemical-mechanical-heat).
- (iv) Exhaust stroke. The exhaust valve opens, the piston moves up and pushes the burnt gases through the exhaust valve.

### **Lesson Flow**

Let the learners carry out the related activity in learner's book (if it is a mixed school, the number of boys and girls in each group should be balanced).

Put learners in groups (select any number of learners depending on the size of the class) make sure that they work in harmony.

Help them in selecting their group leaders.

Identify learners with special needs in group making. Encourage them to actively participate in their respective groups.

Move around the class guiding learners as they are performing the activity. In case of any assistance you can make bright learners to assist the weak ones.

Let the learners discuss their findings in their groups and finally present to the whole class.

Consolidate the lesson by developing and giving your ideas basing on learners' ideas.

### **Note**

Help the learners to work neatly and systematically.

### **Assessment criteria**

Learners may be assessed using the following methods;

- by asking them oral questions.,



- making learners to work out activities,
- check and mark work of each learner.

The methods mentioned above can be varied. The use of a particular method depends on the size of the class, level of learners, availability of scholastic materials, time of the day and the moods of the learners.

### **References**

Learner's book 4 (Physics for Rwanda Secondary Schools Book 4)

Other available Physics books in the school Library.

## **Lesson 17: A two stroke engine**

Period 17: (40 Minutes)

Step 1: Ask learners to state the four strokes in the four stroke petrol engine.

Step 2: Guide the learners on how the two stroke engine works. Talk about the two strokes of the engine. Explain to the learners that this engine has a [power stroke every down stroke. It has no valves as in a four stroke engine. It relies on the petrol uncovering holes in the cylinder walls to let petrol and air in, and the exhaust gases out. These holes are called ports.

**Compression and explosion:** In this stage the piston is full of petrol-air mixture, with the piston compressing the mixture. As the piston moves up the cylinder, it covers the exhaust and the transfer ports. At the same time, the inlet port is uncovered and the crank case takes in more petrol-air mixture. When the piston reaches the top, the spark plug sparks and explodes the fuel, forcing the piston down.

**Inlet and exhaust:** After a piston has been forced down by exploding fuel, it uncovers the exhaust and transfer ports. The motion of the piston moving down into the crank case, through the transfer port and into the cylinder. The new mixture coming into the cylinder blows the burnt gases out through the exhaust port.

Step 3: Display a chart showing these cycles for the learners to understand better.

Step 4: Guide the learners to discover where the two stroke petrol engine is applicable i. e in small motor cycles, lawn mowers and portable generators.

## Lesson 18: Diesel engines

Period 18: (40 Minutes)

Step 1: Ask learners to give examples of vehicles which use petrol engines.

Build on their responses and explain to the learners the type of vehicles which use diesel engines. The engine is used in heavy vehicles such as lorries, buses, trailers, and ships.

Step 2: Structure of a diesel engine:

**Ask the learners to list down the strokes of a petrol engine. Build on their responses to describe the structure of the diesel engine.**

The Diesel engine uses diesel to operate. A diesel engine can operate by making two or more strokes.

The operation of two and four stroke Diesel engines is similar to that of the petrol varieties. However, diesel is used instead of petrol. There is no spark plug and the carburetor is replaced by a fuel injector.

The main difference between the diesel engine and the petrol engine is the way in which fuel is burnt. In a diesel engine, the injector pump is compressed so much that it becomes hot enough to ignite the diesel.

Step 3: The four stroke diesel engine.

This is the most common type of diesel engine. The sequence of the strokes is;

1. Intake: in this, the inlet valve is open, Piston moves down and air is drawn into the cylinder.
2. Compression: In this, both valves are closed, piston moves and compresses the air and diesel fuel is sprayed through the injector.
3. Explosion: In this, valves are closed, fuel air mixture ignited and the piston moves down because of explosion.
4. Exhaust: In this, the exhaust valve opens and the piston moves up and pushes the burnt gases out through the exhaust valve.

## Lesson 19: A two stroke diesel engine

Period 19: (40 Minutes)

Step 1: Ask learners to describe the working of a four stroke engine.

From their responses, guide them to conclude that the two stroke diesel engine has only the Compression and explosion stroke and the intake and exhaust. This makes the engine more powerful.

Step 2: Display a chart and explain to the learners the two strokes of the engine.

- Compression and explosion: In this, the piston moves up compressing the air in the cylinder making it hotter. Diesel is then sprayed through the injector. The heat of compression ignites the fuel and the explosion forces the piston down.
- Intake and exhaust: In this, the piston is forced down by the exploding diesel fuel, uncovering the exhaust and the inlet ports. Compressed air is blown in through the inlet port and burnt gas out through the exhaust port, and fills the cylinder with fresh air. The cycle is then repeated.

Step 3: Differences between a petrol engine and a diesel engine.

Ask learners to state the differences from the structures of the engines and their workings.

Step 4: Advantages of diesel engine over petrol engines.

Instruct learners to work through the activity 20 on page 376 in the learner's book.

Diesel engines, sometimes called compression ignition (C. I) engines, though heavier than petrol engines, are reliable and economical. Their efficiency of about 40% is higher than that of any other heat engine. A disadvantage of the diesel engine is that its higher compression ratio means that it needs to be more robust, and is therefore more massive

### Lesson Flow

Let the learners carry out the related activity in learner's book (if it is a mixed school, the number of boys and girls in each group should be balanced).

Put learners in groups (select any number of learners depending on the size of the class) make sure that they work in harmony.

Help them in selecting their group leaders.

Identify learners with special needs in group making. Encourage them to actively participate in their respective groups.

Move around the class guiding learners as they are performing the activity. In case of any assistance you can make bright learners to assist the weak ones.

Let the learners discuss their findings in their groups and finally present to the whole class.

Consolidate the lesson by developing and giving your ideas basing on learners' ideas.

### **Note**

Help the learners to work neatly and systematically.

### **Assessment criteria**

Learners may be assessed using the following methods;

- by asking them oral questions.
- making learners to work out activities.
- check and mark work of each learner.

The methods mentioned above can be varied. The use of a particular method depends on the size of the class, level of learners, availability of scholastic materials, time of the day and the moods of the learners.

### **References**

Learner's book 4 (Physics for Rwanda Secondary Schools Book 4)

Other available Physics books in the school library.

## **Lesson 20: The refrigerator**

---

Period 20: (40 Minutes)

Step 1: Ask learners to work through activity 21 on page 376 of the learner's book.

Step 2: Display a chart and explain how the refrigerator works.

A refrigerator is used to cool substances. It cools things by evaporation of a volatile liquid called Freon. The coiled pipe around the freezer at the top contains Freon which evaporates and takes latent heat from the surroundings so causing cooling. The electrically driven pump removes the vapour and forces it into heat exchanger (pipes with cooling fins outside the rear of the refrigerator). Here the vapour is compressed and liquefies giving out latent heat of vaporization to the surrounding air. The liquid returns to the coils around the freezer and the cycle is repeated. An adjustable thermostat switches the pump on and off, controlling the rate of evaporation and so the temperature of the refrigerator.

Guide the learners to discover that it uses a process which is a cycle of evaporation, compression cooling, evaporation again.

Step 3: Look around the school where there could be a refrigerator and take learners to observe. Give more clarifications from there.

### **Lesson 21: Heat engines and climate change**

Period 21: (40 Minutes)

Step 1: Put learners in groups of five and ask them to discuss the causes of pollution in Rwanda.

Let the group leaders present their findings.

Possible answers: Smoke from industries pollutes air and spills of oils from cars pollute water in the rivers.

Guide the learners to conclude that most of air pollution is caused by the burning of fuels such as oil, natural gas and gases as a result of combustion.

Step 2: In groups of five, ask the learner to explain how water and air pollution affect the environment and the climate.

Possible answers: people inhale the gases and get poisoned.

When it rains, the oil spills are transported into rivers and since oil is less dense than water, it settles on top and prevents evaporation.

Guide the learners to discover how air pollution has an adverse effect on the climate. Climate change is the greatest environmental threat of our time endangering our health.

When a heat engine is running, it emits greenhouse gases, such as carbon dioxide, which contributes to global warming. Fuels used in heat engines contain carbon. The carbon burns in air to form carbon dioxide. The Carbon dioxide and other global warming pollutants collect in the atmosphere and act like a thickening blanket, and destroy the ozone layer. Therefore the sun's heat from the sun is received direct on the earth surface and causes the planet to warm up. As a result of global warming, the vegetation is destroyed; ice melts and water tables are reduced.

Heat engines especially diesel engines produce Soot. The dark particles in the soot absorb incoming and scattered heat from the sun; they can promote the formation of clouds that can have either cooling or warming impact; and black carbon can fall on the surface of snow and ice, promoting warming and hence increasing melting.

Similarly, some engines leak for example old car engines, and oil spills all over. When it rains, this oil is transported by rain water to lakes and rivers. The oils then create a layer on top of the water and prevent free evaporation of the water.

Step 3: Put the learners in groups of five and discuss ways of reducing the effects of heat engines on the environment.

Possible answers: Banning old vehicles from towns

### **Lesson Flow**

Let the learners carry out the related activity in learner's book (if it is a mixed school, the number of boys and girls in each group should be balanced).

Put learners in groups (select any number of learners depending on the size of the class) make sure that they work in harmony.

Help them in selecting their group leaders.

Identify learners with special needs in group making. Encourage them to actively participate in their respective groups.

Move around the class guiding learners as they are performing the activity. In case of any assistance you can make bright learners to assist the weak ones.

Let the learners discuss their findings in their groups and finally present to the whole class.

Consolidate the lesson by developing and giving your ideas basing on learners' ideas.

**Note**

Help the learners to work neatly and smartly.

**Assessment criteria**

Learners may be assessed using the following methods;

- by asking them oral questions.
- making learners to work out activities.
- check and mark work of each learner.

The methods mentioned above can be varied. The use of a particular method depends on the size of the class, level of learners, availability of scholastic materials, time of the day and the moods of the learners.

**References**

Learner's book 4 (Physics for Rwanda Secondary Schools Book 4)

Other available Physics books in the school library.

## UNIT 12

# General Structure of the Solar System

**Learner's book pages 383-415**

**Key unit competence:** By the end of the unit, the learner should be able to illustrate and describe the general structure of the solar system.



### Learning objectives

---

Learners should be able to:

- identify and explain scales for estimate astronomical distances.
- explain the phenomenon of eclipse.
- explain the phenomenon of phases of the moon.
- distinguish the inner and outer planets.
- outline and describe the positions of the eight planets with the sun.
- differentiate comets and meteorites and asteroids.
- explain Kepler's laws.
- state Kepler's laws.
- solve some problems related to Kepler's laws.
- observe the universe and identify planets and stars.
- distinguish a star and a planet.
- explain the existence of constellations.
- define and apply celestial coordinates.
- identify celestial coordinates.
- define and apply celestial coordinates.
- identify celestial coordinates.

This unit is to be taught in 20 lessons, each of 40 minutes.

Evaluation must be done in allocated time.



### Unit Breakdown

Serial number	Lesson title	Number of minutes	Periods
1	• Astronomical scales	80	2
2	• Sun-Moon-Earth system • Eclipses (Lunar and solar eclipses) • Phases of the moon	160	4
3	• The solar system • Inner and outer planets • Comets • Meteorites • Asteroids • Kepler's laws	240	6
4	Kepler's laws :Exercises	80	2
5	Stars patterns: Constellations	80	2
6	• Celestial coordinates • Equatorial coordinates system • Horizontal coordinates system	80	4
	Total	800	20

#### Lesson 1: Astronomical scales

Period 1: (80 Minutes)

- Step 1: The teacher will introduce the lesson showing to learners that the scale depends on the measurement wanted to be done. He will guide the learners to discover that in astronomy, the meter cannot be used due to big distances to be measured. So other scales can be used.
- Step 2: Set the learners to work through activity 1 on page 384. Make sure that all steps are followed. The activity must be read carefully by learners before to be performed.
- Step 3: Ask the learners to emphasise on the case they have because they have to know how to convert to astronomical scales.

Step 4: Ask the learners to read through the information in the learner's book on the page 383-385.

### **Lesson Flow**

Let the learners carry out the related activity in learner's book (if it is a mixed school, the number of boys and girls in each group should be balanced).

Put learners in groups (select any number of learners depending on the size of the class) make sure that they work in harmony.

Help them in selecting their group leaders.

Identify learners with special needs in group making. Encourage them to actively participate in their respective groups.

Move around the class guiding learners as they are performing the activity. In case of any assistance you can make bright learners to assist the weak ones.

Let the learners discuss their findings in their groups and finally present to the whole class.

Consolidate the lesson by developing and giving your ideas basing on learners' ideas.

### **Note**

Help the learners to work neatly and systematically.

### **Assessment criteria**

Learners may be assessed using the following methods;

- by asking them oral questions.
- making learners to work out activities.
- check and mark work of each learner.

The methods mentioned above can be varied. The use of a particular method depends on the size of the class, level of learners, availability of scholastic materials, time of the day and the moods of the learners.

### **References**

Learner's book 4 (Physics for Rwanda Secondary Schools Book 4)  
Other available Physics books in the school Library.

## Lesson 2: Sun-Moon-Earth system

Period 2: (160 Minutes)

### Eclipses (Lunar and solar eclipses)

- Step 1: Explain to learners that in their motion, the earth and the moon can occupy different positions so at a certain time rays from the sun cannot reach the moon or the earth due to the position of one of them. In that case, we have an eclipse. He'll show the difference between a lunar eclipse and a solar eclipse.
- Step 2: Ask the learners if they have ever seen an eclipse. Was it a solar or a lunar eclipse? He'll explain that solar eclipses are much rarer but today they will be lucky enough to see both.
- Step 3: Instruct learners to carry out activity 2 on page 387. Let them create an eclipse by performing the experiment. Let them follow step by step procedures.
- Step 4: Instruct the learners to read through the information below activity 2, before the following activity.
- Step 5: Instruct learners to consider the apparatus in activity 2 and carry out activity 3 on page 389. Let them perform the experiment following step by step.
- Step 6: Ask them to read through the information in the learner's book.

### Information to the teacher

On page 390 figure 12.1, surrounding the shadow cone, also called the umbra, is an area of partial shadow called the penumbra. The approximate mean length of the umbra is 1,379,200 km; at a distance of 384,600km, the mean distance of the moon from the earth, it has a diameter of about 9170km.

Before the moon enters the umbra in either total or partial eclipse, it is within the penumbra and the surface becomes visibly darker. The portion that enters the umbra seems almost black, but during a total eclipse, the lunar disk is not completely dark; it is faintly illuminated with a red light refracted by the earth's atmosphere, which filters out the blue rays. Occasionally a lunar eclipse occurs when the earth is

covered with a heavy layer of clouds that prevent light refraction; the surface of the moon is invisible during totality.

### **Related to the solar eclipse and the Figure 12. 2**

The length of the moon's umbra varies from 367, 000 to 379, 800 km, and the distance between the earth and the moon varies from 357, 300 to 407, 100 km. Total solar eclipses occur when the moon's umbra reaches the earth. The diameter of the umbra is never greater than 268.7km where it touches the surface of the earth, so that the area in which a total solar eclipse is visible is never wider than that and is usually considerably narrower. The width of the penumbra shadow, or the area of partial eclipse on the surface of the earth, is about 4828km. At certain times when the moon passes between the earth and the sun, its shadow does not reach the earth. At such times, an annular eclipse occurs in which an annulus or bright ring of the solar disk appears around the black disk of the moon.

The shadow of the moon moves across the surface of the earth in an easterly direction. Because the earth is also rotating eastward, the speed of the moon shadow across the earth is equal to the speed of the moon traveling along its orbit, minus the speed of the earth's rotation. The speed of the shadow at the equator is about 1706 km/h; near the poles, where the speed of rotation is virtually zero, it is about 3380km/h. The path of a total solar eclipse and the time of totality can be calculated from the size of the moon's shadow and from its speed. The maximum duration of a total solar eclipse is about 7. 5 minutes, but these are rare, occurring only once in several thousand years. A total eclipse is usually visible for about 3 minutes from a point in the center of the path of totality.

### **Phases of the moon**

Step 1: Introduce the lesson by asking learners if the moon appears in the same way all time in the sky. Probably they'll say no. Guide the learners to discover that there are different phases of the Moon that make it appear a little different every day, but it looks the same again about every four weeks. The Moon can sometimes be seen at night and sometimes during the day.

Step 2: Instruct the learners to carry out activity 4 on page 391 which will be the focus of the discussion. In groups of 3 to 5 learners let them discuss following; the instructions spelt out in the activity.

Suggested answers: (a) At night, Yes, it can be seen during the day too. At different times of the month it is easier to see. (b) Sometimes you can only see a little white sliver and sometimes you can see the whole moon. (c) Explain that it takes the moon 29 days (about 1 month) to travel around the earth and the different phases that we see are when the moon is at different points in that orbit.

Step 3: After discussion, ask the learners to read through the information about it in the learner's book.

### **Information to the teacher**

Through the use of probing and through provoking question lead the learners to develop notes similar to the set below.

The Moon's orbit around Earth is tilted  $5^\circ$  from the plane of Earth's orbit. Because of this tilt, when the Moon is at the point in its orbit when it is between Earth and the Sun, the Moon is usually a little above or below the Sun. At that time, the Sun lights the side of the Moon facing away from Earth, and the side of the Moon facing toward Earth is dark. This point in the Moon's orbit corresponds to a phase of the Moon called the new moon. A quarter moon occurs when the Moon is at right angles to the line formed by the Sun and Earth. The Sun lights the side of the Moon closest to it, and half of that side is visible from Earth, forming a bright half-circle. When the Moon is on the opposite side of Earth from the Sun, the face

of the Moon visible from Earth is lit, showing the full moon in the sky.

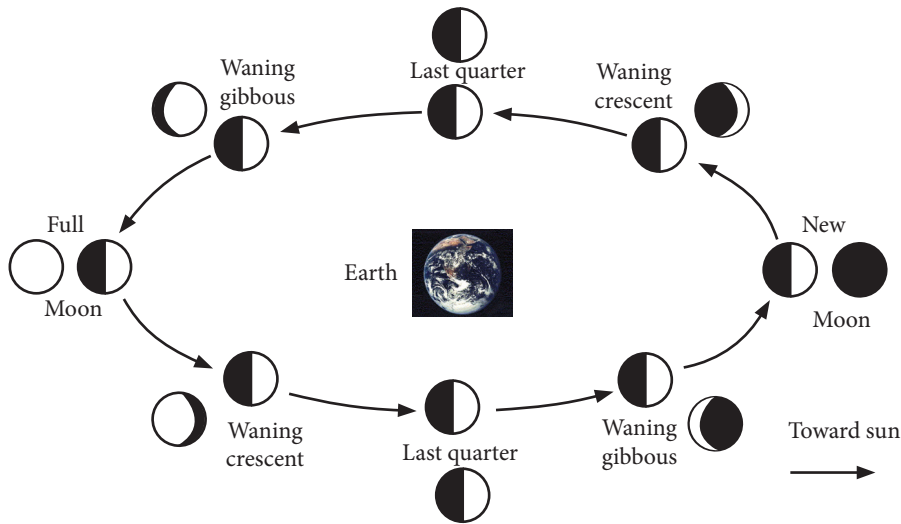

In the figure, we can see different phases for which explanations are given.

### **First quarter**

When the Moon reaches the first quarter of its phases, it appears as a half-moon. One half of the Moon is now lit up by sunlight.

### **Waxing Gibbous**

After the first half-moon, or first quarter, the Moon moves towards full moon. As more of it is lit up, the Moon is said to be waxing. It is also said to be gibbous (between a semicircle and a full circle in shape).

### **Full Moon**

When the Moon appears as a full moon, all of its visible side is in sunlight.

### **Waning crescent**

After a full moon, the Moon begins to decrease again. The Moon is now said to be waning. It is also said to be gibbous (between a semi circle and a full circle in shape).

**Last quarter**

The Moon continues waning until it reaches its last quarter, also known as half-moon.

**Waning Gibbous**

After a full moon, the Moon begins to decrease again. The Moon is now said to be waning. It is also said to be gibbous (between a semicircle and a full circle in shape).

**New moon**

With a new moon, the Moon is between the Sun and the Earth, causing none of the illuminated side of the Moon to be visible to the Earth.

**Waxing crescent**

After a new moon, the Moon moves through a crescent phase. The moon is now said to be waxing.

**Lesson Flow**

Let the learners work through the related activity in learner's book (if it is a mixed school, the number of boys and girls in each group should be balanced).

Put learners in groups (select any number of learners depending on the size of the class) make sure that they work in harmony.

Help them in selecting their group leaders.

Identify learners with special needs in group making. Encourage them to actively participate in their respective groups.

Move around the class guiding learners as they are performing the activity. In case of any assistance you can make bright learners to assist the weak ones.

Let the learners discuss their findings in their groups and finally present to the whole class.

Consolidate the lesson by developing and giving your ideas basing on learners' ideas.

### **Note**

Help the learners to work neatly and systematically.

### **Assessment criteria**

Learners may be assessed using the following methods;

- by asking them oral questions.
- making learners to work out activities.
- check and mark work of each learner.

The methods mentioned above can be varied. The use of a particular method depends on the size of the class, level of learners, availability of scholastic materials, time of the day and the moods of the learners.

### **References**

Learner's book 4 (Physics for Rwanda Secondary Schools Book 4)  
Other available Physics books in the school Library.

## **Lesson 3: The solar system**

---

Period 3: (240 Minutes)

Inner and outer planets

- Step 1: While introducing the lesson, through review of the previous lesson, the teacher will define what the solar system is. He'll show different constituents of a solar system and show that the aim of the lesson is the study of that.
- Step 2: Let the learners carry out activity 5 on page 393. Pass around to guide with the learners. Give some material to learners performing the activity. Step by step the activity must be carried out. It's an interesting activity so that learners can go away from lesson spirit and think that it's a game. You must watch out that issue.
- Step 3: After the activity, assign the learners to read through the notes below activity 5.

### **Inner and outer planets**

- Step 1: Ask the learners to present their findings from the previous activity.
- Step 2: Give information to learners about the lesson and what they will be discussing.



### **Information to the teacher**

The table below constitutes more information about Inner and Outer planets: Ask the learners to make short notes on the inner and outer planets after their research. Discuss with your learners the importance issues related to the topic.

#### **The Inner Planets**

##### **Mercury, Venus, Earth and Mars**

###### **Small size**

Earth is the largest of the Inner Planets, with a diameter of 12, 756 km (7, 926 miles). Mercury is the smallest with a diameter of 4, 878 km (3, 031 miles)

###### **Have solid surfaces and thin/no atmospheres**

In theory, it would be possible to stand on each of the Inner Planets, although you would only survive on Earth.

###### **Greater Density**

The size and composition of the planets is caused by the density of the elements that make up the planets. The elements in the Inner Planets are more closely packed together, causing them to be smaller on solid.

#### **The Outer Planets**

##### **Jupiter, Saturn, Uranus and Neptune**

###### **Huge!**

Jupiter, the largest planet, has a diameter of 142, 984 km (88, 846 miles). Neptune is the smallest of the Outer Planets with a diameter of 49, 532 km (30, 779 miles)

###### **Balls of gas with no surface**

Most of the Outer Planets are made of gas. It is likely that they have a much smaller solid or liquid centre. It would be impossible to stand on any of the Outer Planets.

###### **Smaller Density**

Despite being larger, the elements that make up the Outer Planets are less densely packed together causing them to be quite light for their size.

#### Varied atmospheres

The contents of the atmospheres of the Inner Planets varies from planet to planet. Mercury has no atmosphere although Sodium and Helium can be detected above the surface. Venus' atmosphere is mostly Carbon Dioxide with a very small amount of Nitrogen. Earth's atmosphere is mostly Nitrogen with a smaller amount of Oxygen and even smaller amounts of other gases. Mars has a similar composition of carbon dioxide and nitrogen as Venus although has a much thinner atmosphere.

#### Known by the ancients

The existence of the Inner Planets has been known about for thousands of years. The earliest astronomers didn't know that the four objects (including Earth) were planets, but they knew they existed.

#### Spin slowly

Compared to the much larger Outer Planets, the Inner Planets spin quite slowly. Earth spins the quickest, taking 23 hours and 56 minutes to spin on its axis. Venus takes 243 days to spin on its axis, spinning in an opposite direction to the other planets.

#### Orbit the Sun quickly

Because they are quite close to the Sun, the Inner Planets complete an orbit quickly. Mercury takes only 88 days to orbit the Sun. Mars takes 687 days.

#### Similar atmospheres

The atmospheres of the Outer Planets consist mostly of Hydrogen and Helium, with Methane also being present in the atmospheres of Uranus and Neptune. Other gases are present although in much smaller quantities.

#### Not known by the ancients

Of the Outer Planets, only Jupiter and Saturn were observed by ancient astronomers. The existence of Uranus and Neptune was not known until relatively recently. Uranus was discovered in 1781 and Neptune in 1846.

#### Spin quickly

All of the Outer Planets spin quicker than the Inner Planets. Uranus spins slowest, taking 17 hours and 14 minutes to spin on its axis. Jupiter takes only 9 hours and 55 minutes to spin on its axis. This rapid rotation causes Jupiter and Saturn to appear squashed, wider across the equator than from top to bottom.

#### Orbit the Sun slowly

The Outer Planets orbit the Sun from millions of miles and have a much greater distance to cover to complete an orbit, so take much longer to do so. Jupiter takes almost 12 years to complete an orbit and Neptune takes over 164 years.

**Few Moons**

Only Earth and Mars have moons orbiting them. One moon orbits Earth and two small moons orbit Mars.

**Lots of Moons**

All of the Outer Planets have many moons orbiting them. There are 63 moons known to orbit Jupiter, 60 orbiting Saturn, 27 orbiting Uranus and 13 orbiting Neptune.

**No rings**

None of the Inner Planets have rings orbiting them

**Rings**

All of the Outer Planets have rings orbiting them. The rings are thin discs of dust and rocks possibly caused by moons being broken up or not being completely formed while orbiting the planet. Saturn has the most visible ring system of any of the planets.

**Multiple space craft visitors**

Due to being close to Earth, there have been several missions to the other Inner Planets, especially to Mars and Venus. Mercury has been visited by two spacecrafts.

**All Outer Planets visited by one space craft**

There have been multiple visits to Jupiter and Saturn, but Uranus and Neptune have only been visited once. This was by Voyager 2 (which also visited Jupiter and Saturn)

## **Comets, Meteorites**

- Step 1: Set the learners to carry out activities 6 and 7 on page 400 and 402 is about reading notes and understandings.
- Step 2: In groups, instruct the learners to read notes. Using probing questions make sure that they have understood what you assigned them to do.
- Step 3: After that, let them answer questions in the activity 6 and activity 7.

---

## **Asteroids**

- Step 1: Let the learners work through activities 8 in the learner's book on page 403.
- Step 2: In groups, let the learners read notes. Using probing questions make sure that they have understood what you assigned them to do.
- Step 3: After that, let them answer questions.

## **Kepler's laws**

- Step 1: Kepler's laws exist. There is a way they are stated. In this lesson let learners carry out activity 9 on page 405 which will help them to recall those laws.
- Step 2: Set the learners to perform the activity following step by step and apply mathematical notions. This part concerns geometry.
- Step 3: In the part (a) of the activity, lead learners to draw manually an ellipse. The pencil will act as the trajectory of a planet moving, describing an ellipse.
- Step 4: In part (b) learners observe areas swept out on the diagram and present a conclusion. Guide learners to discover that these areas are the same. Since the base of these triangles are shortest when the earth is farthest from the sun, the earth would have to be moving more slowly in order for this imaginary area to be the same size as when the earth is closest to the sun.
- Step 5: For part (c) there is a table containing some data for planets Earth and Mars. The purpose is to show that values  $T^2/R^3$  are almost equal for those planets but here quantities are in SI units. Let learners fill the missing data in the last column.
- Step 6: In (d) there is a table containing data for all planets. The purpose is the same as in (c). To fill the last column in order to conclude the third law.
- Step 7: Lead the learners to discover that the activity was related to laws called Kepler's laws for planetary motion. From the activity lead the learners to develop and state Kepler's laws.

### **Information to the teacher**

Most planetary orbits are almost circles, and careful observation and calculation is required in order to establish that they are actually ellipses. Calculations of the orbit of the planet Mars first indicated to Johannes Kepler its elliptical shape, and he inferred that other heavenly bodies, including those farther away from the Sun, also have elliptical orbits.

Kepler's work (published between 1609-1619) improved the heliocentric theory of Nicolaus Copernicus, explaining how the planets' speeds varied, and using elliptical orbits rather than circular orbits with epicycles.

Isaac Newton showed in 1687 that relationships like Kepler's would apply in the solar system to a good approximation, as consequences of his own laws of motion and law of universal gravitation.

Kepler's laws are part of the foundation of modern astronomy.

## **Lesson 4: Kepler's laws**

Period 4: (80 Minutes)

### **Exercises**

- Step 1: Set the learners to discuss given questions in groups and guide them as they develop a common solution.
- Step 2: Prepare the lesson because this is to apply what you taught carefully. This is the time to revise and to emphasise on what learners have learned. Remind them what you taught related to the step in question.
- Step 3: You are not obliged to do all questions in the learner's book. Leave others to learners as homework.
- Step 4: In preparing the lesson, choose other questions even outside the learner's book; the purpose is to raise the level of understanding of learners. Know the level, their weakness and how to strengthen them.
- Step 5: Procedures of solving exercises are based on the level of learners.

### **Lesson Flow**

Let the learners do the related activity in learner's book (if it is a mixed school, the number of boys and girls in each group should be balanced).

Put learners in groups (select any number of learners depending on the size of the class) make sure that they work in harmony.

Help them in selecting their group leaders.

Recognise learners with special needs in group making. Encourage them to actively participate in their respective groups.

Move around the class guiding learners as they are performing the activity. In case of any assistance you can make bright learners to assist the weak ones.

Let the learners discuss their findings in their groups and finally present to the whole class.

Consolidate the lesson by developing and giving your ideas basing on learners' ideas.

### **Note**

Help the learners to work neatly and systematically.

### **Assessment criteria**

Learners may be assessed using the following methods;

- by asking them oral questions.,
- making learners to work out activities,
- check and mark work of each learner.

The methods mentioned above can be varied. The use of a particular method depends on the size of the class, level of learners, availability of scholastic materials, time of the day and the moods of the learners.

### **References**

Learner's book 4 (Physics for Rwanda Secondary Schools Book 4)  
Other available Physics books in the school Library.

## **Lesson 5: Stars patterns: Constellations**

---

Period 5: (80 Minutes)

1. This lesson starts by an activity 10 on page 409 of reading and research in internet. Let learners read the provided notes in the learner's book and calmly read and answer questions.
2. Let them search in internet to know more and to finalise the answering of questions.

## Lesson 6: Celestial coordinates

---

Period 6: (80 Minutes)

Equatorial coordinates system

- Step 1: Introduce the lesson by showing the reason why the study of celestial coordinates.
- Step 2: Let learners carry out activity 11 on page 412 which concerns research on internet and answer questions related to the activity.
- Step 3: Some suggested answers in this information are:

There is an important difference between the equatorial and geographic coordinate systems: the geographic system is fixed to the Earth; it rotates as the Earth does. The Equatorial system is fixed to the stars, so it appears to rotate across the sky with the stars, but of course it is really the Earth rotating under the fixed sky.

The *latitudinal* (latitude-like) angle of the Equatorial system is called *Declination* (Dec in short). It measures the angle of an object above or below the Celestial Equator. The *longitudinal* angle is called the *Right Ascension* (RA in short). It measures the angle of an object East of the Vernal Equinox. Unlike longitude, Right Ascension is usually measured in hours instead of degrees, because the apparent rotation of the Equatorial coordinate system is closely related to Sidereal Time and Hour Angle. Since a full rotation of the sky takes 24 hours to complete, there are  $(360 \text{ degrees} / 24 \text{ hours}) = 15 \text{ degrees}$  in one Hour of Right Ascension.

The equatorial coordinates for deep-sky objects and stars do not vary appreciably over short durations of time, since they are not affected by the *diurnal motion* (the daily apparent rotation of the sky around the earth. However, note that this takes 1 sidereal day, as against 1 solar day). They are suitable coordinates for making catalogs of stars and deep-sky objects (note that *Galactic Coordinates* also work well, but are cumbersome to use from an earth point-of-view). However, there are effects that cause the RA and Dec of objects to vary over time, namely Precession and *nutation*, and *proper motion*, the latter being even less important.

### **Horizontal coordinates system**

- Step 1: Set the learners to work through activity 12 on page 413 which concerns reading and research on Internet and answer questions related to the activity.
- Step 2: Let them read the provided notes and carry out research on Internet about horizontal coordinates then answer questions.
- Step 3: Make sure that learners have understood what they read in notes and on Internet.

### **Answers to activity 13 on page 415**

1. Azimuth
2. Altitude
3. Zenith